



# SOLAR STIK<sup>®</sup>

## Setup, Operation, and Maintenance Manual for the 24VDC Li BOS 2000-120







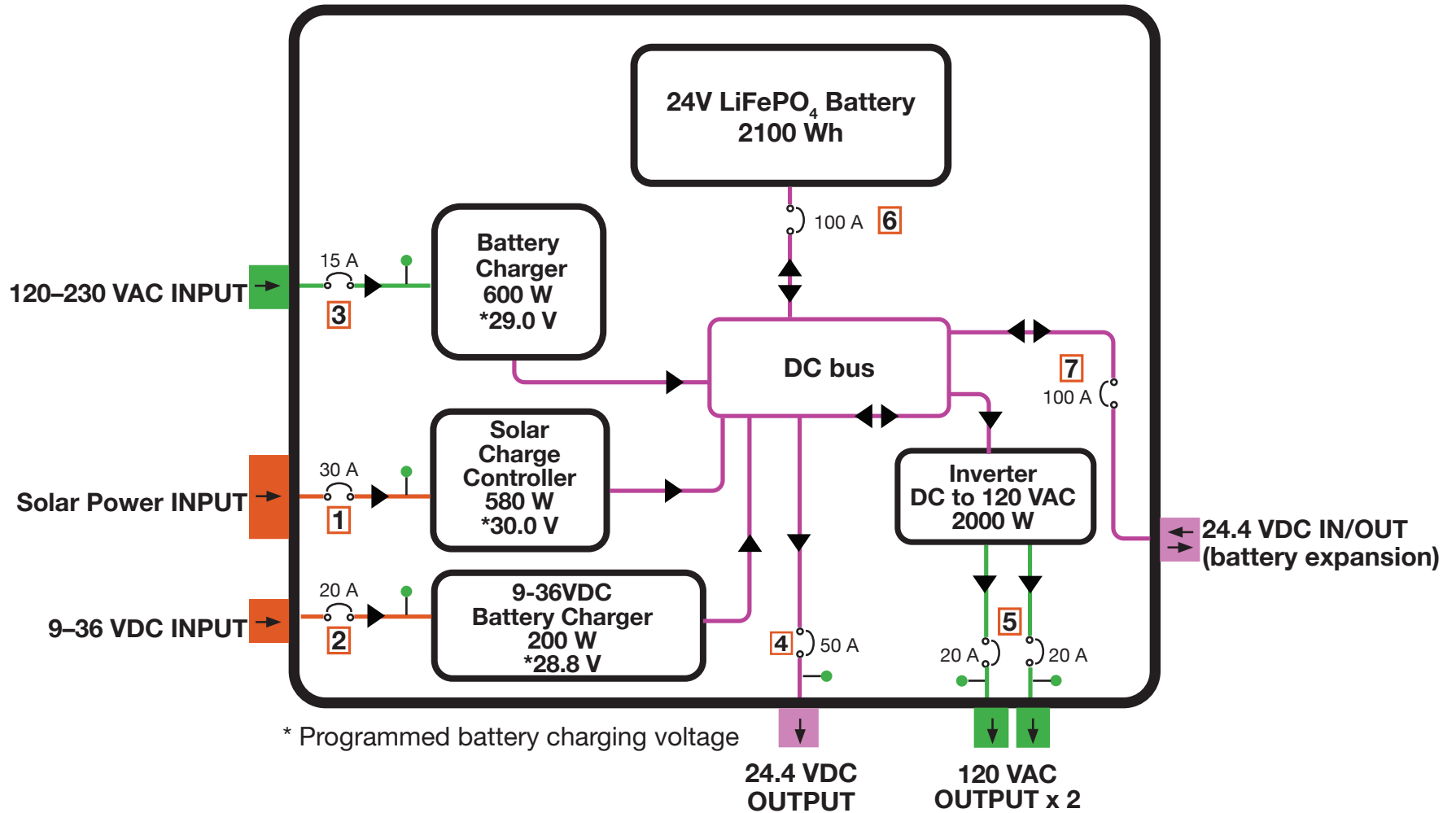

P/N: 20-0205195

DISTRIBUTION STATEMENT A. Approved for public release; distribution is unlimited.

SS20230926

# BOS 2000-120 Electrical Circuits



-  LED circuit activity indicator
-  Circuit breaker location
-  24 VDC bus circuit
-  120 VAC circuits
-  Unregulated DC power input

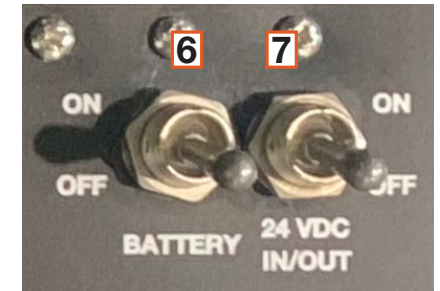
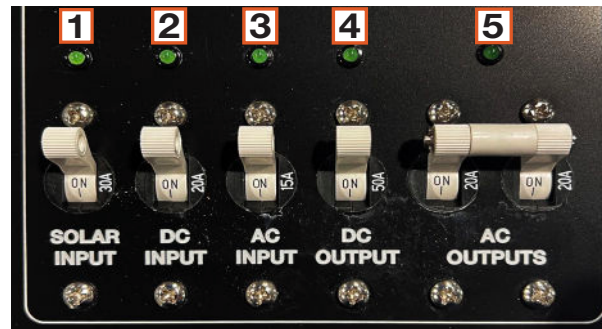

# BOS Electrical / Power Connections and Ventilation

I = Air intake (vent has filter); E = Air exhaust (vent has no filter)

## Power Output



Front

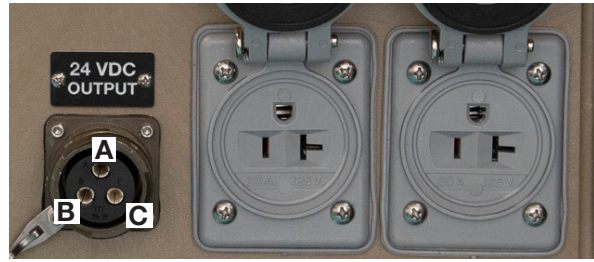

24 VDC  
30 A  
~720 W

120 VAC  
20 A

**24 VDC Output:** Pin A (+), Pin B (-), Pin C (unused)  
DC output voltage is equal to DC bus voltage.

## Power Input

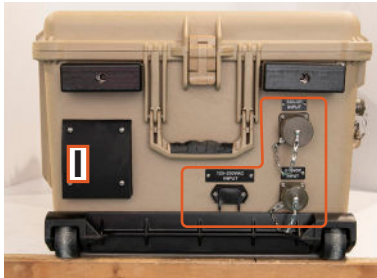

Left

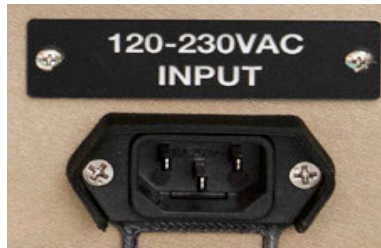

100-240 VAC, 50-60 Hz  
15 A max  
600 W max

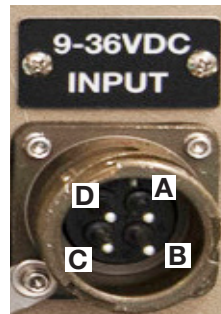

9-36 VDC  
20 A max  
200 W max

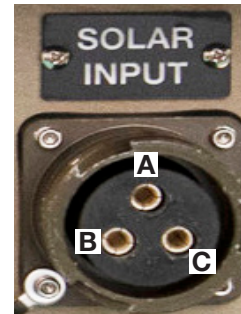

33-100 VDC  
30 A max  
580 W max

**Solar Input:** Pin A (-), Pin C (+), Pin B (unused)  
**9-36 VDC Input:** Pin A (-), Pin C (+), Pins B & D (unused)

## Power Input/Output



Right



24.4-30 VDC  
100 A max  
3000 W max

## Data and Comms

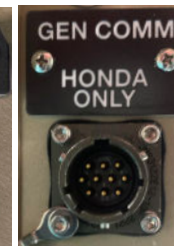

**DATA:** CAN data and comms from internal battery.

**GEN COMM:** BOS control of generator auto start/stop.

Custom cables required.

# BOS 2000-120 Faceplate

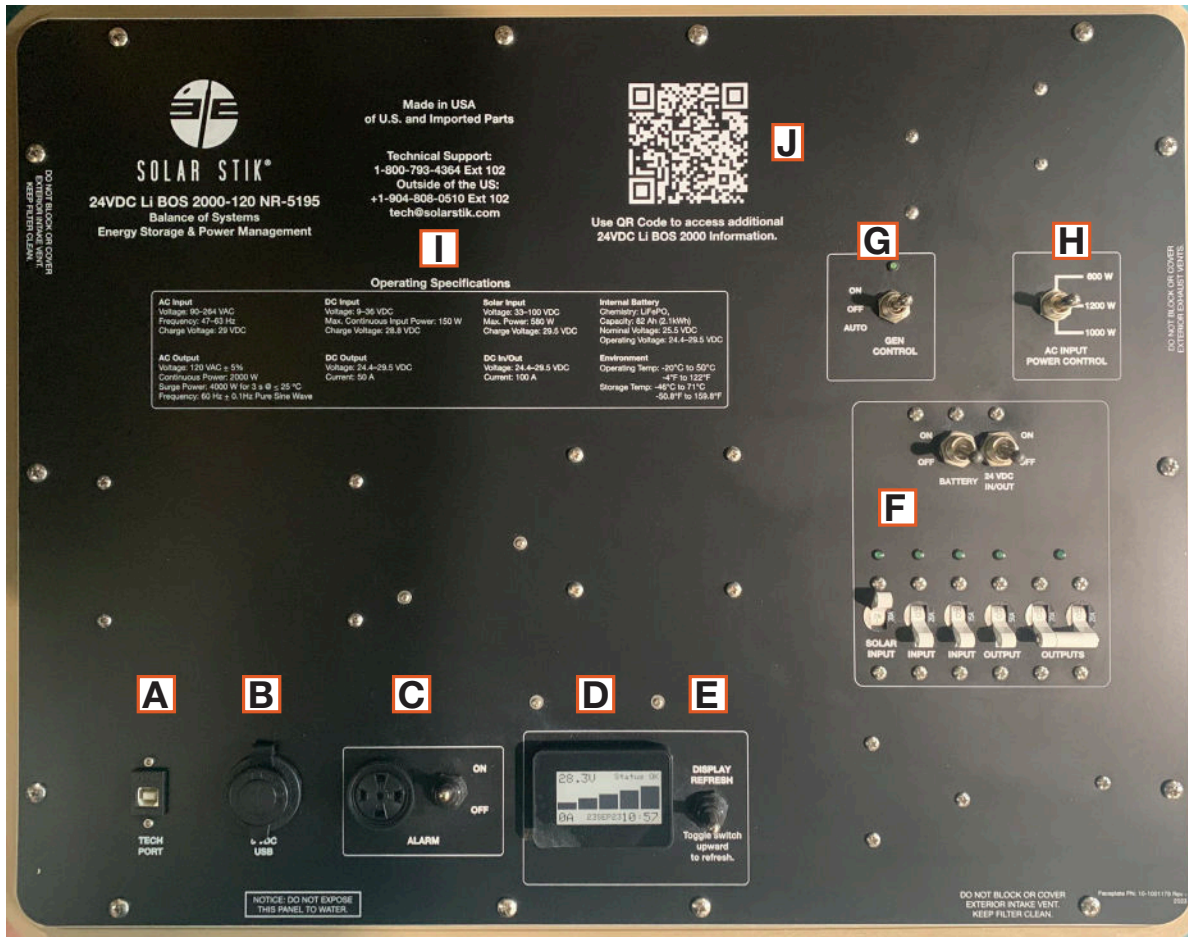

Critical information on BOS setup, operation, and monitoring is provided directly on the BOS Faceplate.

- A. The Tech Port provides programming access to generator auto start/stop circuit. Contact Solar Stik for further information.
- B. 5 VDC USB charging ports (x2) do not transmit data (for device charging only).
- C. AGS Alarm provides audible warning of pending generator start. Alarm may be silenced.
- D. Internal battery status display reports battery voltage, current (A), state of charge, status (fault or OK), date, and time of day.
- E. Battery status display refresh toggle switch
- F. Breaker switch panel and circuit-activity LEDs. See BOS 2000-120 Electrical Circuits (page 2) for details.
- G. Generator auto start/stop and manual-run switch.
- H. AC Input Power Control - Choose a setting that does not exceed the output, in watts, of the power source.
- I. Operational specifications. Provides limits for BOS AC and DC circuits and internal battery specifications.
- J. QR Code link to this manual

# Operation Instructions

## BOS Connections and Activation

1. Ensure all breakers are OFF before connecting anything to BOS.
2. Connect peripherals to be used as part of System (e.g., grid power, solar array, Honda 1 or 2 kW generator, AC and/or DC loads).  
**Note:** Do not exceed load limits listed on Faceplate Specifications and elsewhere in this document.
3. Turn on BATTERY breaker to activate the BOS.  
**Note:** BATTERY breaker must be ON for BOS to operate properly.
4. After the battery self tests have finished, toggle Battery DISPLAY REFRESH switch to update Battery Status Monitor.
5. Toggle ON circuit breakers necessary to support all connected peripherals. Green LED above breaker will illuminate when circuit is powered.

### Notice

- For information on expanding BOS 2000 energy storage capacity, contact Solar Stik.
- Do not connect lead-acid batteries to BOS.
- The BOS should be shaded from direct sun exposure and sheltered from the elements as much as possible during operation.
- Keep the case lid and connector covers closed when not in use to prevent water and dust intrusion.
- Check the integrity of electrical connectors on a monthly basis.
- Do not block air vents on case exterior. Clean or replace air filters form optimum cooling. Spare filters are attached to the inside of the BOS lid.

## BOS Charging and Discharging

### Battery-only Run Times

The BOS internal battery stores 2 kWh of energy when fully charged. Starting with a brand new battery, fully charged, the BOS can support a 200 W load for ~ ten (10) hours, a 500 W load for ~ four (4) hours, or a 2000 W load for ~ one (1) hour. These times will decrease as the internal battery ages and loses storage capacity. This is normal for all batteries.

### Low-voltage Cut Off (LVCO)

The BOS will disconnect AC loads, DC OUTPUT port and USB charging port when the internal battery voltage drops to 24.4. If this occurs, charge BOS immediately. Power will return to loads automatically when battery voltage is  $\geq 25.4$ .

### BOS Charging

Connect active AC and / or DC power source(s). Toggle ON corresponding power input breakers.

**120–240 VAC Charging:** 600 W; minimum charge time from empty is ~ 3.5 h. If AC power source is a Novatio generator, follow directions on BOS Faceplate.

**Solar Charging:** 580 W max; minimum charge time from empty is ~ 3.5 h. Charging will begin when sufficient sunlight is present. Solar power charging speed is a function of connected solar array power output.

**9–36 VDC Charging:** 200 W; minimum charge time from empty is ~ 10 h.

Internal battery is charged fully when charging current approaches zero (0) A (see battery status sections of this document).

# Battery Status Display Home Screen

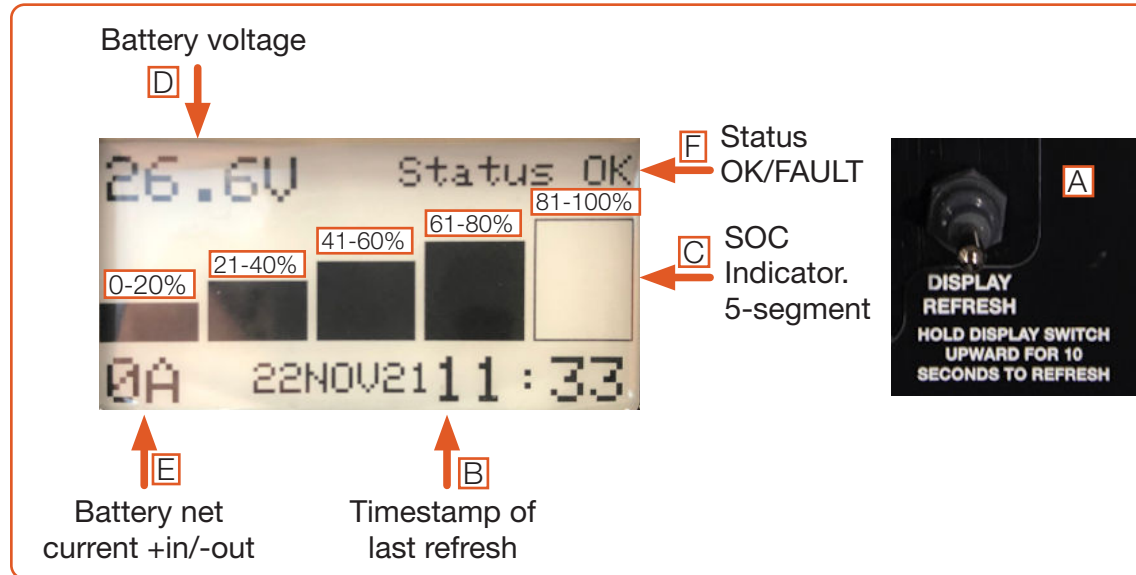

- A.** During normal operation, the display is updated automatically at intervals of three (3) minutes. The DISPLAY REFRESH momentary toggle switch can be pressed and held to update the display during normal operation. The REFRESH DISPLAY switch must be pushed and held until the home page is completely repopulated. If the button is released too soon, the display will not populate. If this happens, wait five (5) seconds, press and hold button until home page is repopulated.
- B.** A timestamp for the last “refresh” is updated and displayed, whether it occurred automatically or by pushing the refresh button.
- C.** The SOC is reported visually by a five-segment “fuel gauge”. Each segment represents 20% increments up to 100%.
- D.** Nominal voltage = 26.4 VDC; voltage @ 100% SOC  $\approx$  30.4 VDC; voltage @ 0% SOC  $\approx$  20.0 VDC.
- E.** The net current (A) with respect to the battery is positive when the BOS internal battery is charging and negative when discharging.
- F.** If / when a battery fault occurs, the word “FAULT” appears in the upper right corner of the display. If the fault is unattended for three (3) minutes, “FAULT” appears in large font, filling the screen. If the fault is not corrected within 60 minutes, the BOS will enter storage mode even with the POWER switch in the ON position.

Additional information about the fault can be found on the second “page” (diagnostic screen) of the Battery Status Display, which is accessed by toggling the Display Refresh switch twice.

## Battery Status Monitor Startup Screens

These two screens scroll by automatically during startup, before the final status screen is populated. This is the location where the firmware version is documented. For more information on the firmware, contact Solar Stik Technical Support.

Screen 1

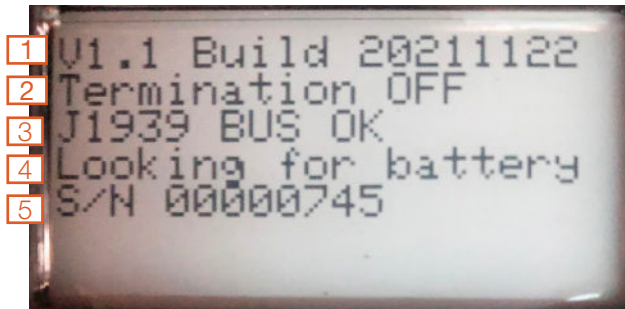

Screen 2

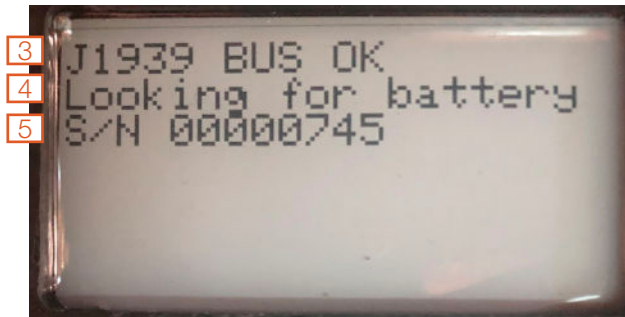

1. Firmware version and date
2. CAN bus auto-termination status
3. CAN bus communication operational
4. Connecting to battery comms
5. Battery serial number

## Battery Warnings and Faults Notifications



An exclamation mark (“!”) will appear in the left-most bar when SOC drops to 0% (top left).

If / when an internal battery fault occurs, the word “FAULT” appears in the upper right corner of the display. If the fault is unattended for three (3) minutes, “FAULT” appears in large font, filling the screen (left). If the fault is not cleared within 60 minutes, the BOS will enter storage mode even with the POWER switch in the ON position.



Additional information about the fault(s) can be found on the second page of the Battery Status Monitor (diagnostic screen).

## Diagnostic Screen

To access the diagnostic screen, toggle the refresh switch once to refresh display then a second time for the diagnostic screen. The image below is an example of the information on the diagnostic screen that is present when the BOS 2000 is operating normally. The SOC value range of a new BOS will narrow as the battery cycles.

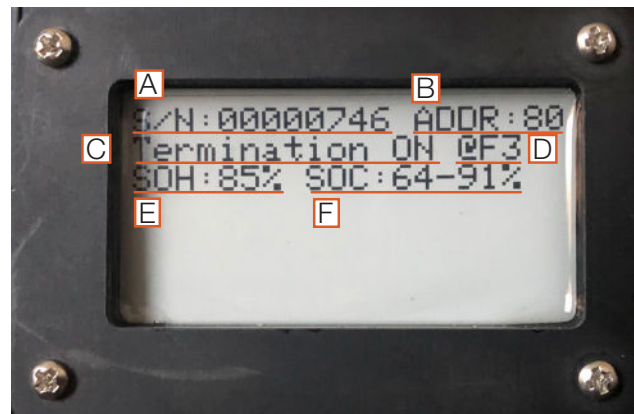

- A. Battery serial number
- B. CAN address for Battery Status Monitor
- C. CAN bus termination status of battery
- D. CAN address of battery
- E. State of health
- F. State of charge

# BOS Internal Battery Troubleshooting

Frequent visual monitoring of BOS 2000 Battery Status Display is the best method to ensure each battery is operating normally. If a NOTIFICATION or FAULT is displayed on the screen, take the prescribed corrective action to clear it.

## Notifications and Faults

Notifications and fault details are found on the diagnostic screen. To access the diagnostic screen, toggle the refresh switch once to refresh the display, then a second time for the diagnostic screen.

### Notifications

**Battery Offline** – This notification indicates that the Battery Status Monitor lost communication with the battery. It may have taken itself offline to protect from overdischarge. Toggle the POWER switch to clear the notification. If the notification doesn't clear, apply a charging source for at least two (2) minutes. If this fails to clear the notification, contact Solar Stik.

**Battery Voltage Low** – “Battery voltage low” notification occurs when the BOS battery voltage falls below 20 VDC. It is only a notification. It does not cause the battery to shut off. This notification automatically clears after charging brings voltage to > 20 VDC.

### Faults

The battery may report one or more faults at a time on the diagnostic screen. If a condition other than the ones shown below appears, contact Solar Stik for assistance. Faults place the BOS 2000 into Protected mode until the fault is corrected and the BOS returns to Operational mode. If the fault is not cleared in 60 minutes, the BOS 2000 will enter Storage mode even if the POWER switch remains in the ON position.

#### Faults reported on diagnostic screen and solutions

Fault Name	Value Exceeded	Clear Value
Critical Cell Overvoltage for 2 minutes	Max Cell V $\geq$ 4.2000 V	Max Cell V < 3.8000 V
Critical Cell Undervoltage	Cell Voltage $\leq$ 2.00 V @ $\leq$ 120 A discharge (battery voltage $\leq$ 16.0 VDC)	Automatically clears fault one time after 2-minute delay. If fault occurs again without charging battery for 2 minutes, must clear by charging for 2 minutes or toggling the POWER switch ON>OFF>ON.
Critical Cell Temp High	Max Cell Temp $\geq$ 169 °F (76 °C)	Reduce Cell Temp to $\leq$ 149 °F (65 °C)
Critical Board Temp High	Max Elec Temp 1 or 2 $\geq$ 248 °F (120 °C)	Reduce Max Elec Temp to $\leq$ 194 °F (90 °C)
Hardware Overload	Current $\geq$ 3000 A	2-minute cool down, followed by toggling the POWER switch ON>OFF>ON
Fast Software Overload	Current $\geq$ 1500A 30 ms	2-minute cool down, followed by toggling the POWER switch ON>OFF>ON
Software Overload	Max Elec Temp 3 $\geq$ 275 °F (135 °C)	2-minute cool down, followed by reducing Elec Temp 3 to $\leq$ 194 °F (90 °C)



# MAINTENANCE CHARGING INSTRUCTIONS

## In-storage BOS Internal Battery Status Information

The Battery Status Monitor will display the last status acquired before the POWER switch was turned OFF. However, battery voltage will decrease during storage due to self-discharge. Toggle ON the POWER switch to update in-storage battery status.

*Never store a BOS in a discharged state! Charge BOS fully before placing in storage.*

*Never store a BOS with the BATTERY switch in the ON position.*

## Temperature-dependent Self-discharge

The self-discharge rate increases as storage temperature increases. If the BOS is stored at temperatures above 90 °F (32 °C), then intervals between maintenance checks and / or charges should be reduced to three (3) months.

## In-storage Battery Status Refresh: Voltage, SOC, and SOH

When the BOS BATTERY switch is OFF, the Battery Status Monitor will continue to report the last-recorded battery status; it does not refresh automatically during storage. The Battery Status Monitor must be refreshed to report the current status while in storage.

1. Toggle ON BOS BATTERY switch.
2. The Battery Status Monitor Screen will populate with up-to-date information. This will take ~ one (1) min. with the several startup tests / results displayed before the Status Monitor is populated.
3. Check voltage and SOC on Home screen.
4. Toggle the REFRESH DISPLAY switch again to move to the Diagnostic Screen to check SOH.

## In-storage Charging

If charging at any temperature lower than 68 °F (20 °C) the internal battery may need to heat to charge optimally. The internal heater may require 650 W. The AC charging source provides 600 W, so the BOS internal battery may use stored energy in addition to the AC power source to heat itself, effectively draining the battery instead of charging. This situation will be apparent if the Battery Status Monitor reports a negative current value during the initial phase of charging and when there is no other load connected to the BOS.

1. Connect a power source to the BOS 2000. AC power will charge fastest, then solar power, then power supplied from 9–36 VDC sources. **Note:** If the BOS battery was previously overdischarged, it will need to be connected to the charge source for at least two (2) minutes, or power-cycled (toggling POWER switch ON>OFF>ON) before charge current will begin to flow.
2. Enable the charging source and allow the BOS to charge. Remember, the battery may heat itself before charging if the BOS internal battery is colder than 68 °F (20 °C).
3. The BOS 2000 should continue to charge, balance, and taper until it reaches the voltage setpoint at less than 0.5 A. At this point the BOS 2000 can be considered to be fully charged.