



SOLAR STIK®

OPERATOR MANUAL FOR 24VDC POWER HUB 3500

P/N 20-0302204



DISTRIBUTION STATEMENT A. Approved for public release; distribution is unlimited.

Version 1.0

Updated: 20231107

November 2023 | Solar Stik Inc.

Interactive

Contents

GENERAL INFORMATION, THEORY OF OPERATION, AND EQUIPMENT DESCRIPTION

Power Hub Introduction	5
Use of the Power Hub in a System	6
Modes of Operation	7
Product Safety Information and Instructions	7
Safety Information Labels	8
Limitations on Liability	8
Fire Hazard	9
Recommended Fire Extinguisher	9
Electric Shock Hazard	10
Environmental and Handling Precautions	11
Water	11
Impact	11
Dust	11
Heat	11

THEORY OF OPERATION

Operation Overview	12
Battery Charging and Recovery	12
Protection Circuits	12
Metered Circuits	13
Maximum Power Point Tracking (MPPT) – Charge Controls	13
Derating	13
The Inter-Connect System	14
Equipment Description	16
Connection Ports and Vents	16
Internal Cooling	18
Information Plate (I-Plate)	18
Faceplate	19

OPERATOR INSTRUCTIONS

Connections	20
Connecting PV Arrays to the Power Hub	20
Connecting Regulated 24 VDC Power Sources	20
Connecting a 24VDC PRO-Verter or 24 VDC Expander Paks	21
Connecting Loads	21
Connecting to Communications Network	21
Powering up the Power Hub	21
The Power Hub User Interface	22
Pages Button	22
Menu Button	23
Device List: Power Hub Circuits	23
Monitoring PV Power: Current and Historical	24
PV Power: Understanding Reported Values	24
Monitoring System Batteries: Current and Historical	25
Battery Monitor: Understanding Reported Values	26
Heat and Derating	27
Causes of Overheating	27

Power Hub Internal Cooling	27
Power Hub Internal Temperature Report	27
User Interface Settings Menus	28
Power Hub Stacking	30
Storing the Inter-Connect Cable	31
Locking Component Cases to Prevent Tampering	31
Transporting the Power Hub	32
Water Intrusion Remediation	32
TROUBLESHOOTING PROCEDURES	
Power Hub Will Not Power Up	33
Performance Issues, Causes and Solutions.	33
Data Logging and Remote Monitoring	34
Performance and Troubleshooting	34
Data Storage and Retrieval	34
MicroSD Card Formatting	35
Remote Monitoring	35
Solar Charge Controller Error Codes	37
MAINTENANCE INSTRUCTIONS	
Preventive Care and Maintenance	40
Cleaning Power Hub Filters	40
SUPPORTING INFORMATION	
Using the Power Hub to Monitor PV Array Performance	41
Assessing PV Array Performance	41
Troubleshooting Individual PV Arrays Using the Power Hub User Interface	41
Specifications	42
ABOUT SOLAR STIK, INC.	
Contact	43

List of Figures

Figure 1. A Power Hub in a Hybrid Power System..... 5

Figure 2. How a Power Hub works in a System 6

Figure 3. 24VDC Power Hub 3500 7

Figure 4. Inter-Connect Plug 15

Figure 5. Overview of Power Hub connections 16

Figure 6. Front—DC output and communications..... 16

Figure 7. Right Side—Regulated 24 VDC input and NATO connector 17

Figure 8. Left Side—Solar-only ports 17

Figure 9. Back side—air intake vent..... 18

Figure 10. Power Hub I-Plate 18

Figure 11. Power Hub Faceplate features 19

Figure 12. Power Hub Solar Input Only connectors..... 20

Figure 13. Power Hub regulated 24 VDC inputs..... 20

Figure 14. Power Hub PRO-Verter or Expander Pak connection..... 21

Figure 15. Power Hub 24 VDC IN/OUT ports 21

Figure 16. Power Hub Tech port..... 21

Figure 17. LCD user interface and navigation guide 22

Figure 18. Data views displayed in “Pages” 22

Figure 19. Device list on user interface 23

Figure 20. Power Hub as the primary power management device 26

Figure 21. Power Hub as the secondary power management device..... 26

Figure 22. Power Hub internal temperature report on user interface 27

Figure 23. Stacking Power Hubs 30

Figure 24. Inter-Connect Cable storage 31

Figure 25. Steel-reinforced padlock holes..... 31

Figure 26. Lock securing Power Hub lid 31

Figure 27. Drain plug screw located under the TECH PORT..... 32

Figure 28. Micro SD card port location 34

Figure 29. Cleaning the air intake filter 40

List of Tables

Table 1. Symptoms and Solutions for the Most Common Power Hub Issues 33

Revision History

Section	Page(s)	Description	Date
		First published	FEB 2019

GENERAL INFORMATION, THEORY OF OPERATION, AND EQUIPMENT DESCRIPTION

Power Hub Introduction

The primary function of the DC Power Hub is to serve as a singular collection, management and distribution tool for DC power in a Hybrid Power System (HPS).

The Hub is designed specifically for operation between energy-storage batteries and DC generation sources, including photovoltaic (PV) arrays, wind generators, fuel cells, small hydro generation, vehicular power, and more. It regulates the incoming power, making it compatible for a connected battery, loads, or distribution devices such as inverters.

Power Hubs play a critical role in applications where any combination of the following is necessary:

- Renewable power generation is required to support a battery
- Reducing generator run-time in a hybrid system is critical
- Less reliance on grid-utility power is desirable
- DC power management and distribution is required for a battery platform

It is a modular component of the HPS architecture, and its flexible design allows use with other technologies that collectively meet specific mission requirements.

All Power Hubs are “Plug & Play”-compatible with the Inter-Connect circuit and are modular and scalable. Their design allows multiple Power Hubs to be used in a single application where power management requirements exceed the ability of a single Hub, or when multiple DC loads are required to meet the demand.

The Power Hub includes one DC Inter-Connect Cable for connection to an HPS.

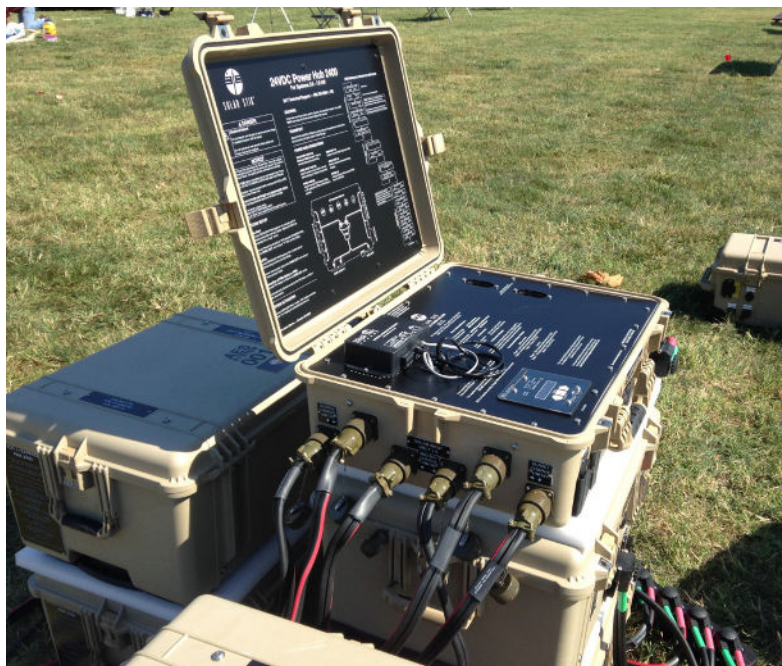

Figure 1. A Power Hub in a Hybrid Power System

Use of the Power Hub in a System

The Power Hub provides a portal to integrate multiple DC power sources into a hybrid power network, including unregulated PV power and power from regulated sources (Figure 2). It funnels all incoming power to the batteries, PRO-Verters, or loads automatically, using basic programming in the User Interface to direct the flow.

Programming and connection of the Hub in a System will vary according to the specific functions the system in which it is employed, but systems vary in accordance with the operator’s requirements. Consequently, not every feature in the Power Hub may be used for an application.

The Power Hub can support operation with either lead-acid or lithium battery types. Other changes in programming may improve performance in extreme environmental operating conditions.

This manual provides an overview of the core features and capabilities of the Power Hub along with a guide for the user interface menu windows. Contact your field service representative (FSR) for assistance in altering operation configurations or programming.

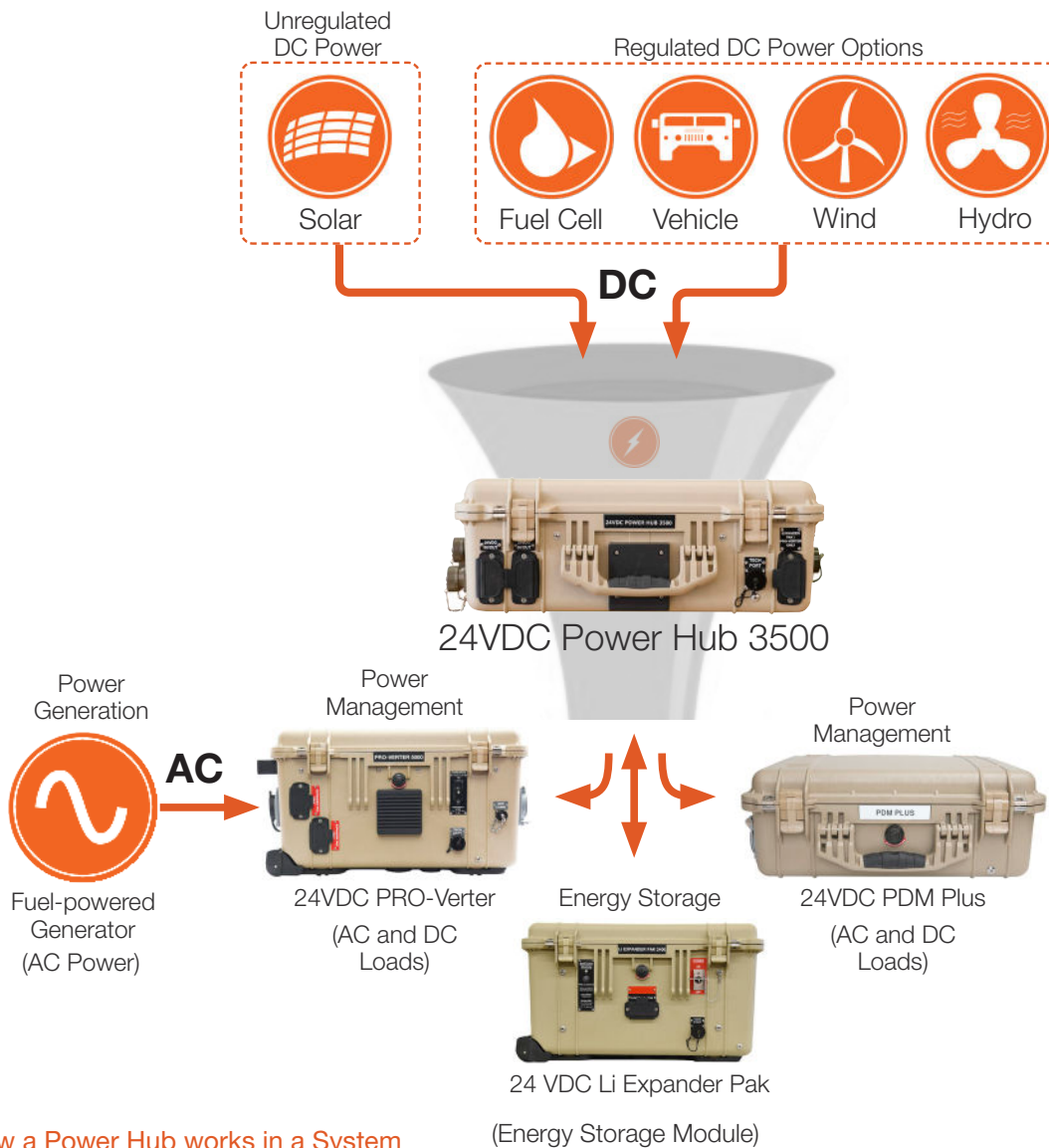

Figure 2. How a Power Hub works in a System

Modes of Operation

Depending on the application, there are several operational modes that can be configured using a Power Hub:

- **Hybrid**

DC loads, DC generation and batteries are all connected to a Power Hub. It is the central power management device in the system. The Power Hub provides constant DC power to a load by alternating between power from batteries and power from a DC generator (such as a PV array). In the hybrid configuration, the batteries cycle regularly, which maximizes electrical efficiency throughout the circuit, minimizing dependency on any one DC source.

- **Direct DC Support**

The Power Hub can be configured to provide DC into a system configuration where DC is used for any of the following:

- Peak Shaving
- Inverter operation
- Battery charging

Product Safety Information and Instructions

This manual contains important safety instructions that must be followed during the installation and operation of this product. Read all instructions and safety information contained in this manual before installing or using this product.

All electrical connections must be made using the proper polarized connectors.

While this product is designed for indoor/outdoor operation, the interior of the Power Hub 3500 must not be exposed to rain, snow, moisture, or liquids. Close and latch and/or lock the cases when the System is unattended.

The Power Hub is not field serviceable beyond simple preventive maintenance. Do not attempt to open or service the unit. If repair is needed, contact your FSR.

Exercise caution when handling or operating the Power Hub. Live power may be present at more than one point.



Figure 3. 24VDC Power Hub 3500

Safety Information Labels

Your safety and the safety of others is very important.

Always read and obey all safety messages.



This is the safety alert symbol. This symbol alerts you to potential hazards that can kill you or hurt you and others. All safety messages will follow the safety alert symbol and the word “DANGER”, “WARNING”, or “CAUTION”. These words are defined as:



Indicates a hazardous situation which, if not avoided, **will result in death or serious injury.**



Indicates a hazardous situation which, if not avoided, **could result in death or serious injury.**



Indicates a hazardous situation which, if not avoided, **could result in minor or moderate injury.**

All safety messages will tell you what the potential hazard is, how to reduce the chance of injury, and what can happen if the instructions are not followed.

Limitations on Liability

Since the use of this manual and the conditions or methods of operation, use, and maintenance of this product are beyond the control of Solar Stik, this company does not assume responsibility and expressly disclaims liability for loss, damage, or expense—whether direct, indirect, consequential, or incidental—arising out of or anyway connected with such operation, use, or maintenance.

Due to continuous improvements and product updates, the images shown in this manual may not exactly match the unit purchased.

This equipment **CAN BE USED FOR CONNECTION WITH LIFE SUPPORT SYSTEMS OR OTHER MEDICAL EQUIPMENT** or devices; however, without limiting the generality of the foregoing, Solar Stik makes no representations or warranties regarding the use of the System in connection with life support systems or other medical equipment devices.

Fire Hazard

Fire Types

Class A fire - Fires in ordinary combustibles such as wood, paper, cloth, trash, and plastics.

Class B fire - Fires in flammable liquids such as gasoline, petroleum, oil, and paint.

Class C fire - Fires involving energized electrical equipment such as motors, transformers, and appliances. Remove the power source and the class C fire becomes a class A or B fire.

Recommended Fire Extinguisher

NSN 4210-00-288-7219 Fire Extinguisher, Carbon Dioxide, 10 lb

Carbon dioxide is a liquefied gas, which is highly effective fighting class B and C fires. These extinguishers are ideal for areas where contamination and/or cleanup are a concern, such as data processing centers, labs, and telecommunication rooms.

WARNING
Only CO ₂ (carbon dioxide) fire extinguishers should be used with equipment.



Using the Fire Extinguisher

When using the extinguisher on a fire, remember PASS:

Pull the pin.

Aim the nozzle or hose at the base of the fire from a safe distance.

Squeeze the operating lever to discharge the fire extinguishing agent.

Sweep the nozzle or hose from side to side until the fire is out. Move forward or around the fire as the fire diminishes.

Watch the area for reignition until the cause has been fixed.

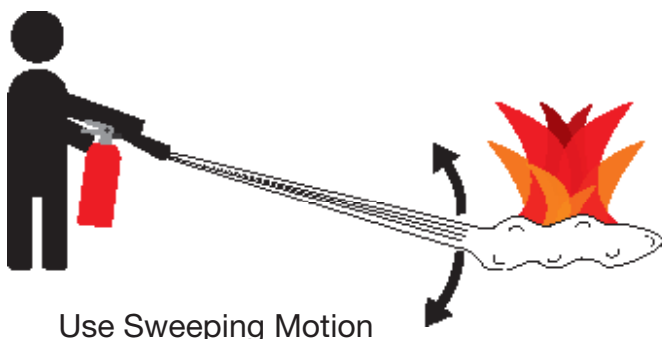

These additional cautionary steps will ensure your safety:

- System components should not be operated in standing water.
- Close and latch the component lids if it is precipitating.
- System cables should not be routed through standing water.
- Cable connections should remain dry.
- Unused ports on System components should be covered when not in use to reduce the possibility of water intrusion.

Electric Shock Hazard

⚠️ WARNING

Standing water around the electrical equipment and/or intrusion of water into the System components can increase the risk of electrical shock.



DON'T LET THIS BE YOU!

HIGH VOLTAGE: System components, PV arrays, and generators may have lethal line voltages. Extreme care should be taken to protect against electrocution. Always work with another person in case an emergency occurs. Disconnect power before performing maintenance. Wear safety glasses whenever working on any part of a System that requires exposure to mechanical or direct electrical contacts.

Environmental and Handling Precautions

All components are ruggedized, yet there are a few things the operator can do to prevent failures and prolong the operational life of the product.

Water

If outdoor operation is necessary, the lids of all components should be closed and latched whenever possible. **Lids should only be open to access operator controls and closed at all other times.**

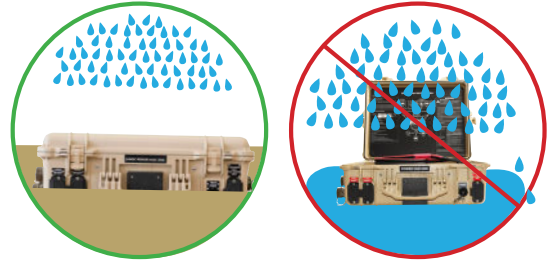

Impact

Equipment should not be dropped onto hard surfaces at a height greater than one foot when transporting or during operation.

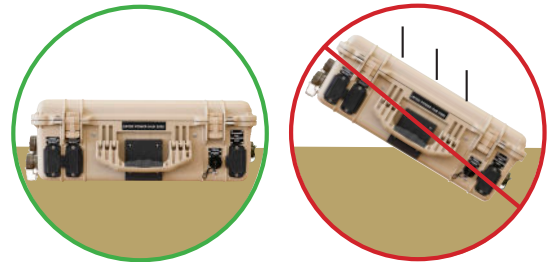

Dust

- Air intake filters should be cleaned once per month, or more frequently when conditions warrant.
- As a general rule, minimize exposure to high levels of particulates by exercising common-sense placement.

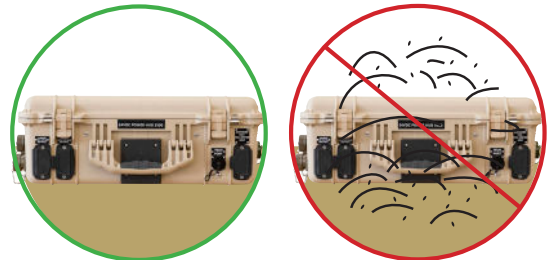

Heat

Heat and solar loading reduces efficiency, causes Power Hub derating, and shortens life expectancy. **Shade the Power Hub** to prevent the negative effects of heat.

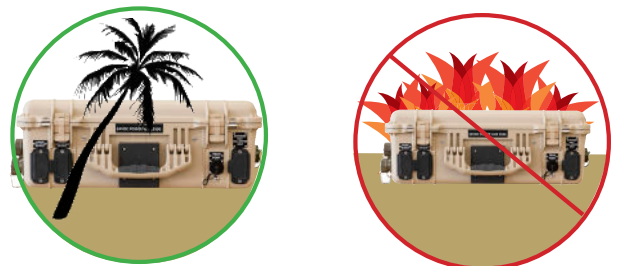

THEORY OF OPERATION

Operation Overview

The Power Hub has multiple DC connections on its exterior, allowing for multiple configuration possibilities.

It requires connection to an active 24 V battery circuit in order for it to operate. A minimum of three (3) energy storage modules (i.e., Expander Paks) must be present and functioning for the Power Hub to be able to operate at its rated power, however, for lower power configurations, a single energy storage module (ESM) or small bank of ESMs may be used.

The Hub has an internal DC bus that can support multiple **regulated** DC generation sources to include the following:

- Wind
- Fuel Cell
- Vehicular
- Hydro

It also has a dedicated circuit for managing **unregulated** power from PV arrays. The Hub has a sophisticated ultra-fast Maximum Power Point Tracking (MPPT) PV charge controller system that regulates PV power, and optimizes PV power production based on two factors:

1. Available PV power
2. Battery State-of-Charge (SoC)

The MPPT process allows a PV array to operate at its rated/available voltage, turning the higher PV voltage into charging current (amps), which is then provided to the battery at the appropriate voltage, improving performance and life of the batteries.

Battery Charging and Recovery

The solar charger controllers can be programmed to charge using several algorithms, including multi-stage charging for lead-acid batteries as well as Constant Current / Constant Voltage (CC/CV) for lithium battery types. Selection of charge algorithms should be based on battery chemistry, capacity and operating conditions.

The Power Hub can also be used to resuscitate over-discharged batteries. Incoming PV power will activate the PV controls and begin the charging process, even if the battery voltage has dropped to levels that cause other components (PRO-Verters, Power Distribution Modules, etc) in a system to shut down due to low voltage.

Protection Circuits

The Power Hub serves as a DC junction within the Inter-Connect Circuit. When connected to an active 24V DC Inter-Connect network, it allows DC to flow through its internal bus, with ONLY the PV circuit offering limit protections:

- The bayonet connector for the Solar Leash is keyed and unique to the PV circuit. It cannot be connected improperly, and no other System cable will fit.
- The PV charge controller is fully protected against voltage transients, over-temperature, over-current, reverse battery connections, and reverse PV connections. An automatic current limit feature allows use of its full rated capability without worrying about overload from excessive PV input current.

Other DC power sources and batteries that connect to the Hub have their own individual circuit protections, so the Hub does not need circuit breakers for individual loads or other connected equipment. If a short-circuit conditions occurs within the DC network, only affected batteries, loads, and power sources will engage their protections circuits, leaving non-problematic circuits active. (See Circuit Breaker Protections in the Inter-Connect section for more details.)

Metered Circuits

Information regarding the status of the batteries and the overall flow of power into and out of the system can be obtained from the Power Hub User Interface. Precise data is available in both real-time and historical models.

DC power values are tracked as it flows in through the PV Controller circuits, as well as power that flows out to a connected battery, PRO-Verter or additional Power Hub(s).

Only certain ports are metered on the Hub. Follow recommended connection diagrams on the I-Plate and the System manual for proper metering of DC values.

Maximum Power Point Tracking (MPPT) – Charge Controls

The Power Hub 3500 contains three (3) photovoltaic (PV) charge controllers. Each charge controller has two (2) input ports; both ports are parallel. Being able to monitor each charge controller and its solar input(s) independently at the User Interface facilitates system optimization and troubleshooting of the solar arrays.

Derating

Derating is a condition where the PV power management functions are diminished due to high temperatures.

Excessive heat in the Power Hub reduces its ability to supply to DC into the Inter-Connect circuit (i.e. to the batteries and other connected devices). It is usually caused by poor airflow over the internal charge controls or by solar loading in high-heat environments.

The first indication of heat-related derating may be the appearance that the solar arrays are “not producing any power” when they should be. If this is the case, check the temperatures. (**Note:** The Power Hub User Interface will also report 0 VDC charging current when the System batteries are fully charged.)

If the internal temperature of the Power Hub is greater than 104 °F (40 °C), the Power Hub performance will be degraded (See: [Power Hub Internal Temperature Reading](#)).

If the system is not operating at rated power, be sure to check the air filters on the case of the Power Hub and/or shade the case from direct sunlight if operating outdoors.

The Inter-Connect System

The Solar Stik System is comprised of three distinct types of technologies:

- Energy storage
- Power management
- Power generation

All of the individual Solar Stik components that operate in these categories utilize a unique connection architecture, known as the Inter-Connect Circuit.

The Inter-Connect Circuit is the skeletal backbone of the Solar Stik System's DC power network. It uses a simple, polarized, locking connection that is common throughout the architecture. All Solar Stik power management, energy storage, and power generation components are compatible with the Inter-Connect Circuit.

Using a common, polarized connector allows rapid "Plug & Play" scaling of components, adaptation of capabilities within the architecture, technology refreshment, and swapping of components when conditions warrant.

Communicating Voltage

All Solar Stik components on the Inter-Connect Circuit use one value to successfully operate in concert: battery voltage.

The Inter-Connect Circuit communicates battery voltage to all components on the network, allowing them to independently coordinate their respective functions. Voltage is used to trigger actions such as Automatic Generator Start/Stop (AGS) function, renewable power delegation, power distribution timing, and more.

The Importance of Proper System Connection

While there is no unsafe way to make connections using a common polarized connector, proper setup of the Inter-Connect Circuit is critical in order to properly communicate voltage to all points in the System, ensuring all of the components operate together to provide seamless power.

Setup can also directly impact how power is metered in the network. Power management devices such as Power Hubs and PRO-Verters will meter current as it flows through the circuit, providing critical real-time and historical data the operator can use to troubleshoot, verify system performance, and make programming / architectural changes based on evolving conditions. Consult the System Operator Manual for a connection schematic specific for a particular application.

Circuit Breaker Protections

The Inter-Connect network is protected from overloads and short circuits through a network of circuit breakers strategically placed throughout the circuit. It ensures the potential for a reverse polarity connection within the circuit is minimized. If a problem occurs in a leg of the Inter-Connect Circuit,

the affected leg will disconnect from the primary network, leaving the other circuits functioning. If a major failure occurs in the circuit, then the entire network will shut down.

The Inter-Connect Plug

- Polarized
- 200 A maximum current
- 24 VDC connection only
- Mechanically “locks” into place
- Rotate knob clockwise to lock, counterclockwise to release
- Can be repaired or modified in the field



Figure 4. Inter-Connect Plug

Equipment Description

Connection Ports and Vents

Port placards assist in making the correct connections between components. Please review the information on all of these plates and labels, as they contain the basic information required to set up and operate the Power Hub.

Overview

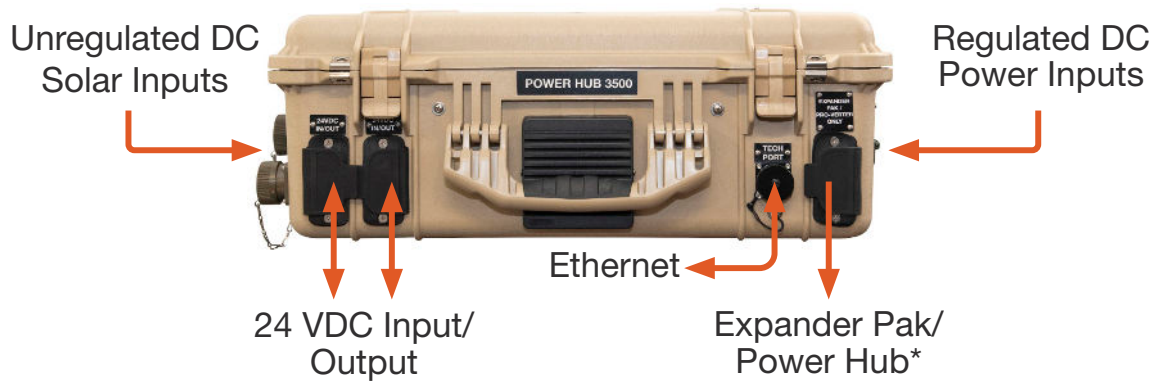

Figure 5. Overview of Power Hub connections



Figure 6. Front—DC output and communications

	Description	Connector	Voltage
A	24VDC Load Port (unmetered)	Inter-Connect Port	24 VDC
B	Exhaust Vent	-	-
C	Ethernet Port	Ethernet - RJF21B	-
D	24VDC Battery/Power Hub Port (metered)	Inter-Connect Port	24 VDC

- A. May be connected to Power Distribution Modules (PDMs; Figure 20) or 24 VDC loads.
- C. For external modem connection to the remote monitoring kit (RMK) if present (optional).
- D. For connection to a 24VDC PRO-Verter or 24VDC Expander Paks(Figure 20, 20)



	Description	Connector	Amps	Voltage
A	24 VDC NATO Slave (unmetered)	NATO Slave	100	24 VDC
B	Regulated 24 VDC Input Only (unmetered)	Inter-Connect Port	100 total	24 VDC

- A. For connection to a tactical vehicle or generator.
- B. For connection to 24 VDC regulated power sources such as wind, vehicle, fuel cell or hydroelectric charging.

Figure 7. Right Side—Regulated 24 VDC input and NATO connector

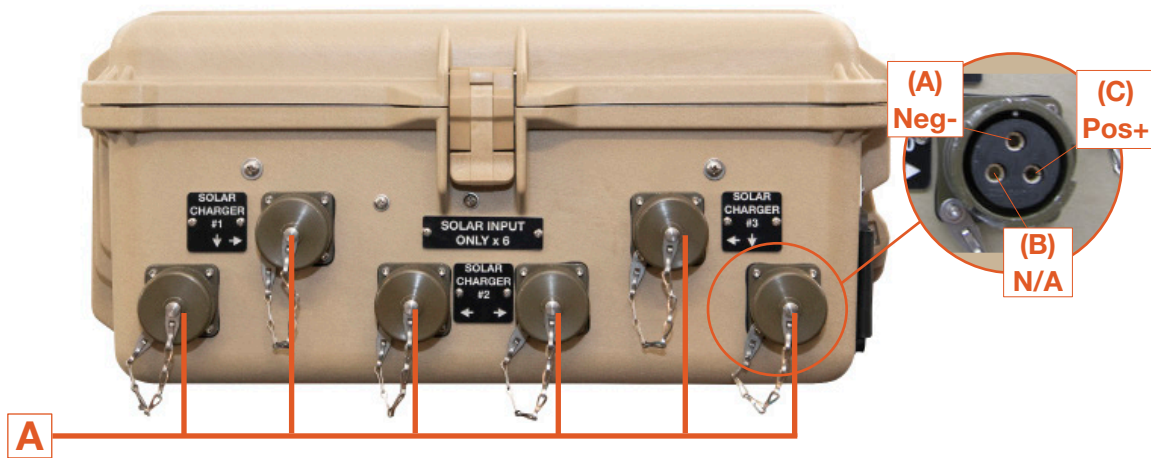

	Description	Connector	Watts	Amps
A	Solar Input	Cannon Bayonet Receptacle CB2-22-2SC	1166 W Max/Solar Charger 3500 W Total	60 A @ 58 VDC 11.7 A @ 100 VDC*

- A. Connections for solar panel input

Figure 8. Left Side—Solar-only ports

Internal Cooling



Thermostatically-controlled, internal cooling fans turn on at 104 °F (40 °C) and turn off when the internal temperature drops to 90 °F (32 °C).

Figure 9. Back side—air intake vent

Information Plate (I-Plate)

The Power Hub I-Plate provides concise, abbreviated information for setting up and running a Power Hub as part of a System (Quick-start Guide and Operating Information). All System components should be connected as described on the I-Plate. The Warning and Notices are important lists of things to do and not to do. Be familiar with their content before operating the Power Hub. An I-Plate is (usually) tailored to a customer’s specific application. Contact Solar Stik Tech Support for details.

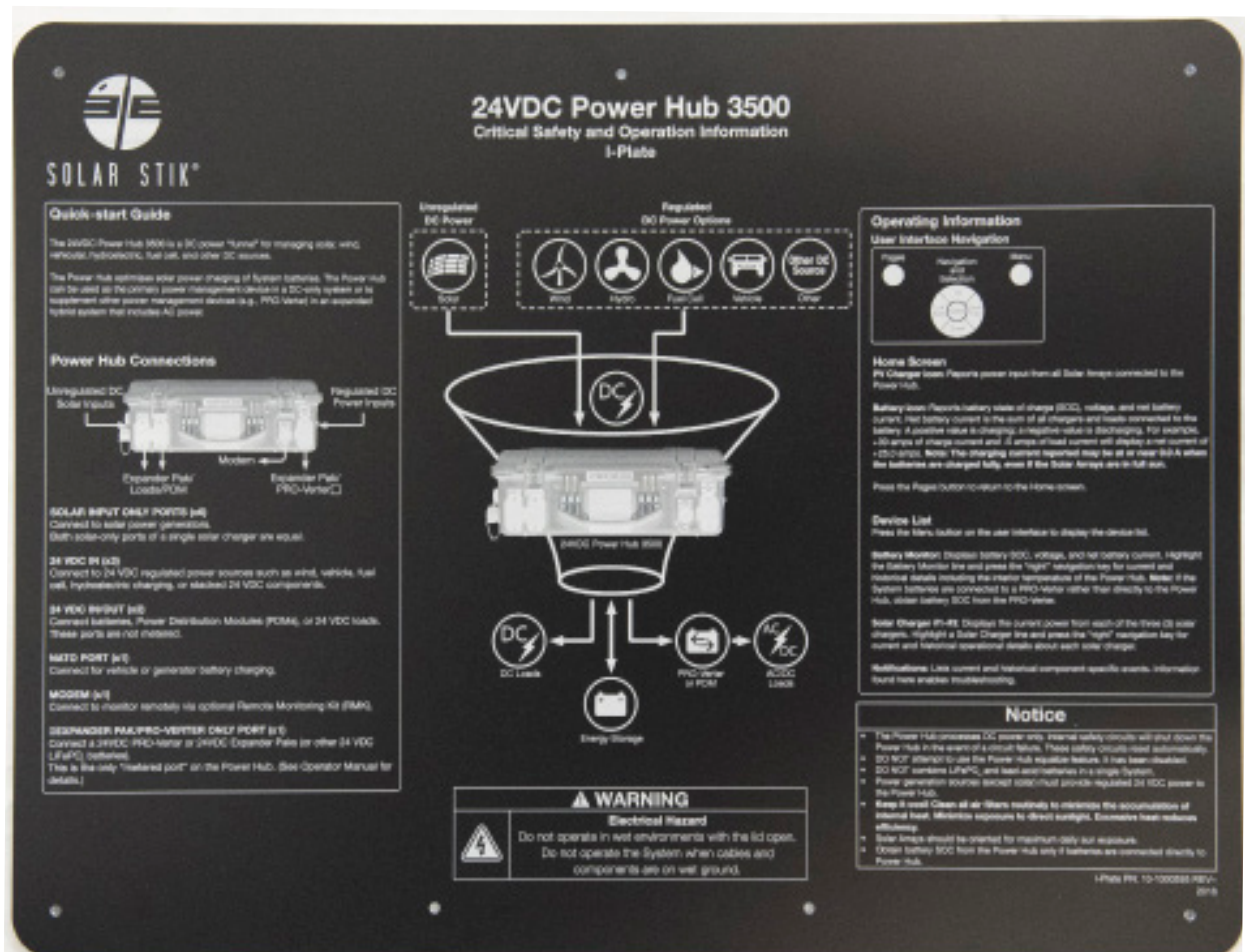

Figure 10. Power Hub I-Plate

Faceplate

The Faceplate provides support for the user interface and the Inter-Connect Cable storage ports. Recommended safety equipment, PV charging specifications, compatible battery chemistries, environmental operating conditions and Solar Stik Technical Support contact information are provided in the center of the Faceplate (Figure 11).

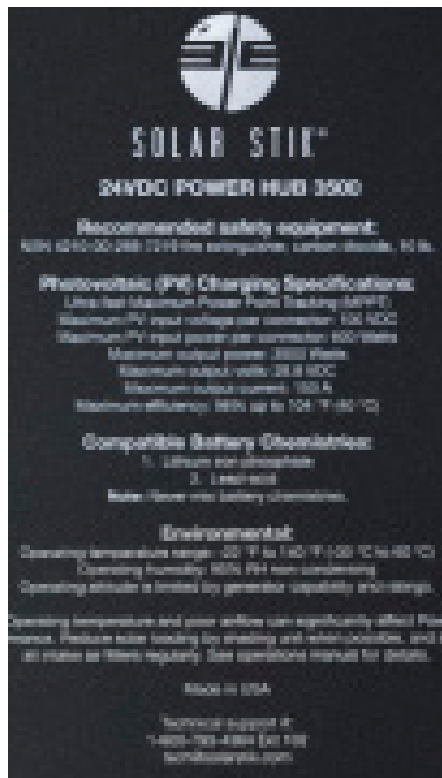
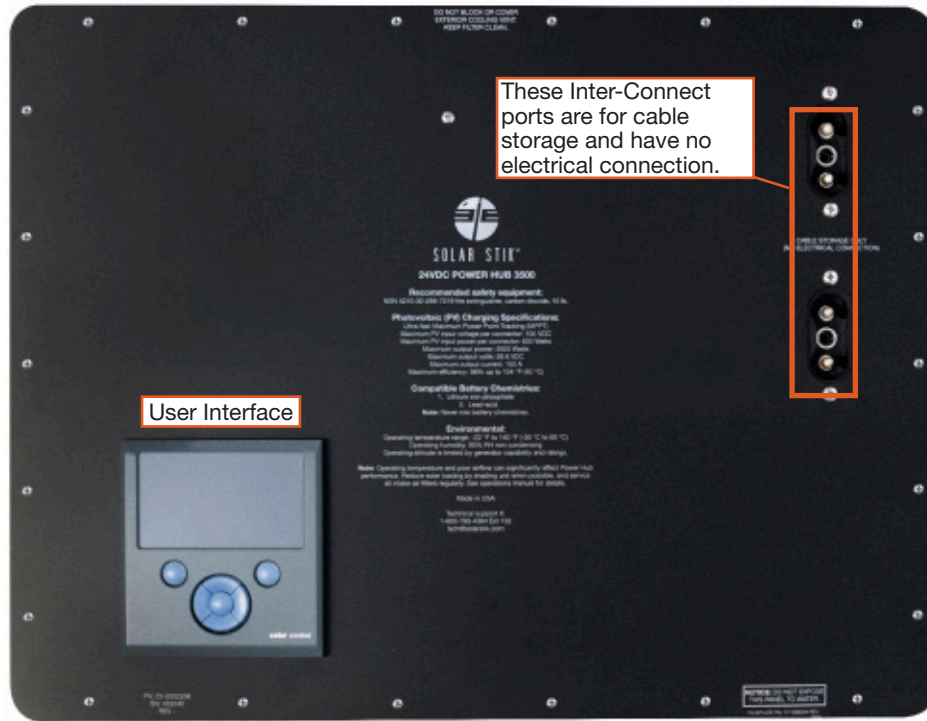

Figure 11. Power Hub Faceplate features

OPERATOR INSTRUCTIONS

Connections

Connecting PV Arrays to the Power Hub

Up to six (6) solar arrays can be connected to the Power Hub Solar Input Only ports using Solar Stik Solar Leashes. The Power Hub 3500 contains three (3) solar charge controllers. Each charge controller has two (2) input ports; both ports are equal. When connecting fewer than four (4) arrays, choose one port from each of the three (3) charge controllers. After the first three (3) ports are connected to solar arrays, the remaining three (3) ports may be connected to additional solar arrays at random.

Each of the three (3) solar chargers safely accepts up to 1166 watts. Different types of solar arrays can be connected to the Power Hub simultaneously as long as their specifications meet the requirements shown on the Faceplate (Figure 11). The bayonet connector for the Solar Leash is keyed and unique to the Solar Stik System (Figure 8). It cannot be connected improperly, and no other Solar Stik System cable will fit.

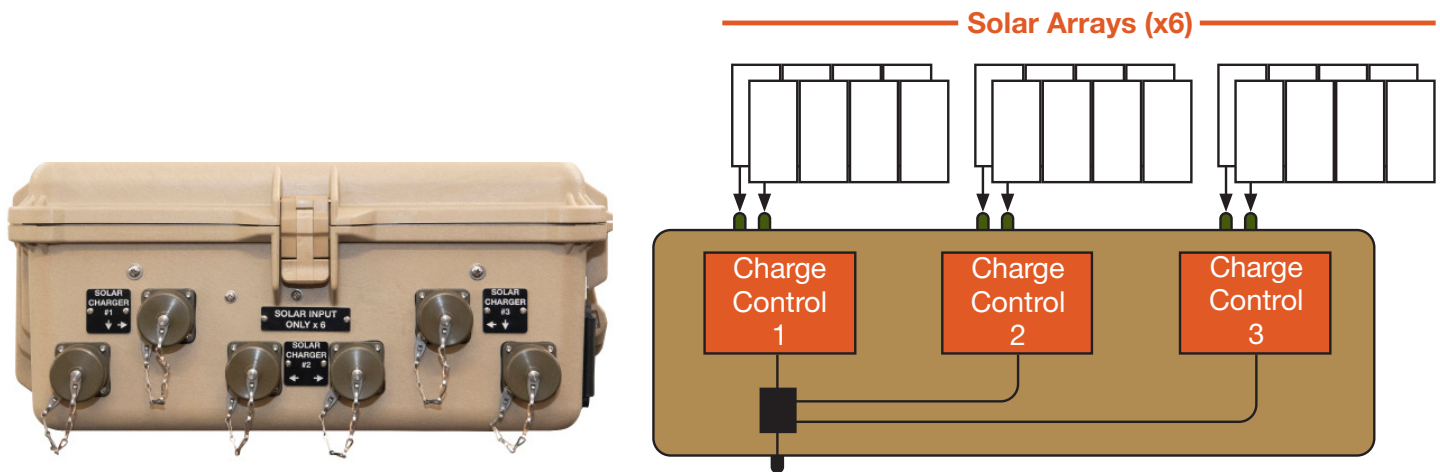

Figure 12. Power Hub Solar Input Only connectors

Connecting Regulated 24 VDC Power Sources



Figure 13. Power Hub regulated 24 VDC inputs

Connect regulated 24 VDC power sources such as wind generators and fuel cells to the three (3) Inter-Connect ports. Connect 24 VDC power from Military Vehicles (e.g., HMMWV) and TQGs to the NATO port.

Connecting a 24VDC PRO-Verter or 24 VDC Expander Paks



Figure 14. Power Hub PRO-Verter or Expander Pak connection

Connect the Power Hub to either a PRO-Verter or Expander Paks using the Expander Pak/PRO-Verter Only port on the right side (orange rectangle) of the Power Hub. Use Inter-Connect Cables to make these connections.

METERED PORT - Data for multiple DC values is collected at this port and is made available at the LCD User Interface.

Connecting Loads



Figure 15. Power Hub 24 VDC IN/OUT ports

Connect loads to the 24VDC In/Out ports on the front left of the Power Hub. Regulated 24 VDC power sources may also be connected here.

Connecting to Communications Network



Figure 16. Power Hub Tech port

Connect to the internet or a computer using the Tech port. This is an Ethernet connection to the LCD user interface and provides remote access to the data provided by it.

Powering up the Power Hub

User Interface

The user interface will activate when the Power Hub Inter-Connect Circuit is active. Power from PV arrays alone will also activate the user interface.

Note: This feature provides a method to bring an HPS (PRO-Verter, Expander Paks, and generator) back online if the System batteries are overdischarged. (See System manual for details.)

Solar Charge Controllers

The solar charge controllers will activate and begin charging when the PV voltage is 5 VDC greater than the battery voltage and will continue charging as long as the PV voltage is 1 VDC greater than the battery voltage.

The Power Hub User Interface

The user interface consists of an LCD screen and buttons for navigating Pages, Menu, and submenu items. Using the buttons and navigating the contents is simple and highly intuitive.

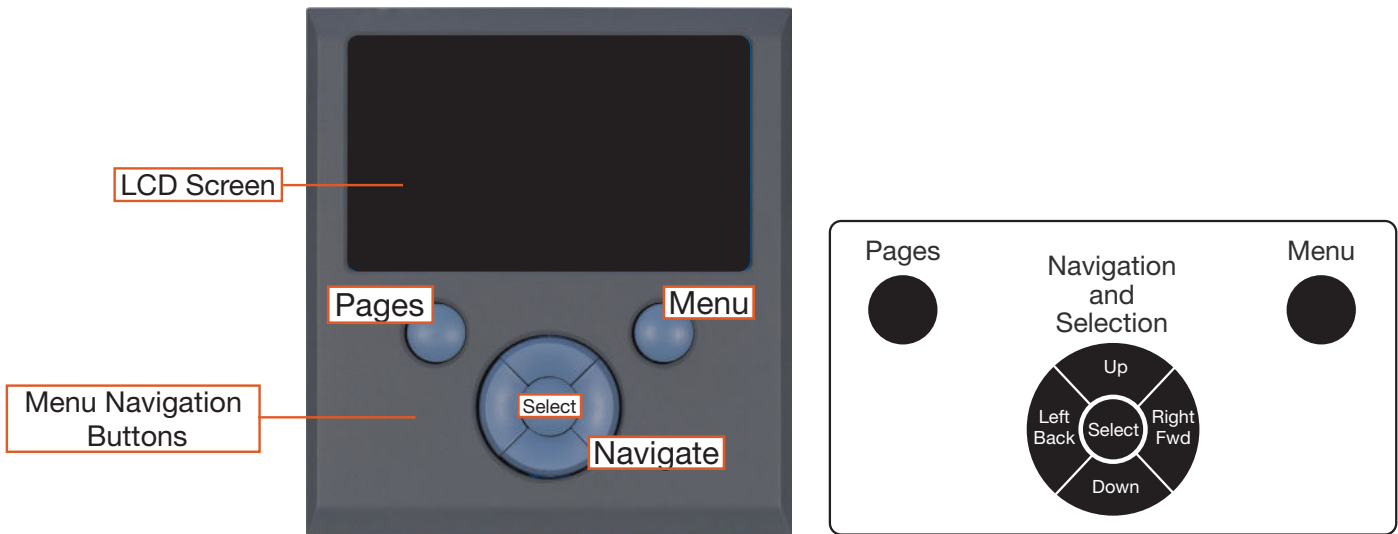

Figure 17. LCD user interface and navigation guide

Pages Button

At the basic level, the information available from the user interface is as follows:

- Power from the PV arrays
- System battery bank voltage
- Net current flowing to or from the System batteries.

Depending on how the System is configured, the LCD shows capabilities that may or may not be utilized by the Power Hub, so icons and windows are visible but may contain "--", indicating no data. Consult the System Manual for additional information about available data and configuring for an application.

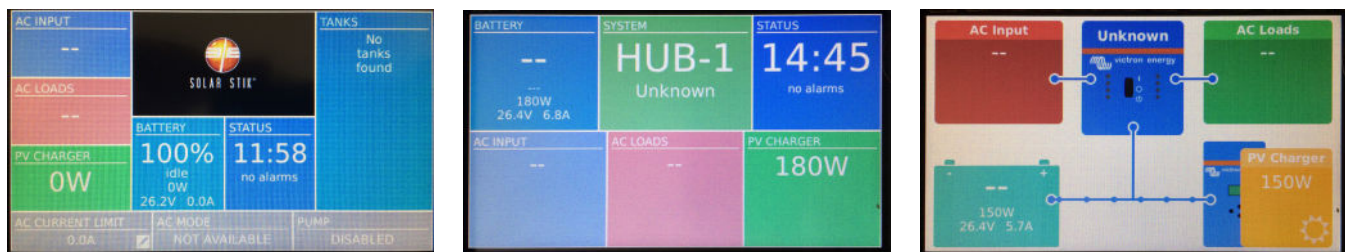

Figure 18. Data views displayed in "Pages"

PV Charger Icon: Reports the cumulative power from the PV arrays connected to the Power Hub. Specific information regarding the power being process by each of the two (2) solar charge controllers is reported in the device list displayed when pressing the Menu Button. Access to this information is described in the [Monitoring PV Power: Current and Historical](#) section.

Battery Icon: Reports battery SOC, voltage, and net current to/from the System battery. The SOC may be reported as “--” until the System batteries cycle enough to “learn” how to calculate accurately the SOC. Net battery current is the sum of all chargers and loads connected to the System batteries. A positive value is net charging; a negative value is net discharging. For example, +30 amps of charge current and -5 amps of load current will display a net current of +25.0 amps.

Note: The net negative current will be observed when the Power Hub is the primary power management device in the System. If the Power Hub is not the primary power management device in the System, obtain the battery SOC from the primary power management device instead. Generally, the primary component is the one that is connected directly to the batteries and is responsible for charging the batteries and supporting the load.

Status Icon: Reports the time of day and “alarms”. A list of the alarms/notifications that may occur, their meanings, and their solutions is provided in subsequent sections of the manual.

Note: The charging current reported may be at or near 0.0 A when the batteries are charged fully, even if the PV arrays are in full sun.

Menu Button

The Menu button provides access to more detailed information from the solar charge controllers and notifications (information about alarms if they occur). Push the Menu button once and the device list appears. This is the starting point for the detailed information about the solar chargers, System batteries (DC bus), notifications, and System settings. Use the navigation buttons of the user interface to navigate submenus under the menu items on the device list.

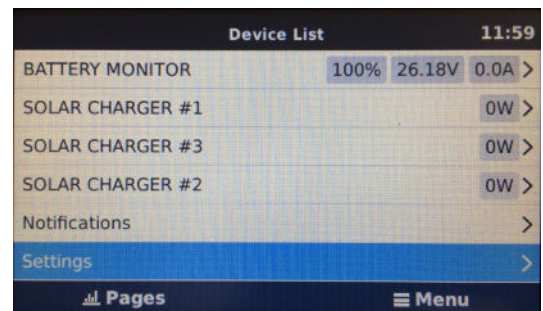

Figure 19. Device list on user interface

Device List: Power Hub Circuits

The Device List is populated automatically by detecting the internal components of the Power Hub and as such is a list of the major functional circuits of the Power Hub.

Battery Monitor Circuit

The battery monitor circuit reports the flow of power from the solar chargers, and other DC power sources onto the DC bus (batteries/Expander Paks) by measuring the DC bus current and voltage. More details about this circuit are in the [Battery Monitor: Understanding Reported Values](#) section.

Solar Charger Circuits

The PV controls convert the higher voltage of the PV arrays so it is compatible with other 24-volt components including batteries and power management. This circuit also uses an MPPT algorithm to extract maximum available power from PV arrays regardless of environmental conditions.

Power Hub Local Time and Date

Set the Power Hub to the local time and date prior to operating or collecting any data to ensure all events are associated with accurate time stamps. To find the time and date settings, press the Menu button to display the device list. Use the down button to highlight the settings line then press Select. Use the down button to scroll to the “Date and Time” (see [User Interface Settings Menus](#)) and press Select. Change the values in the submenu windows to reflect the correct local time and date.

Monitoring PV Power: Current and Historical

Press the Menu button one time to display the device list. The window that will appear is illustrated below. Solar Charger #1 and #2 will appear in lines 2–3. Use the Up/Down navigation buttons to highlight any of the solar chargers. Press Right or Select to open the menu windows specific for that solar charger. The window that appears (Solar Charger #1 in the illustration below) provides an extensive report of the current status for that solar charger. Historical reports for Solar Charger #1 can be displayed by navigating down to the “Daily History” and “Overall History” lines then pressing Right or Select. Data reported in those windows are displayed in the illustration below. Notifications and errors related to solar chargers are found in the Notifications and History Menus.

Note: Values shown in all of the menu windows will vary.

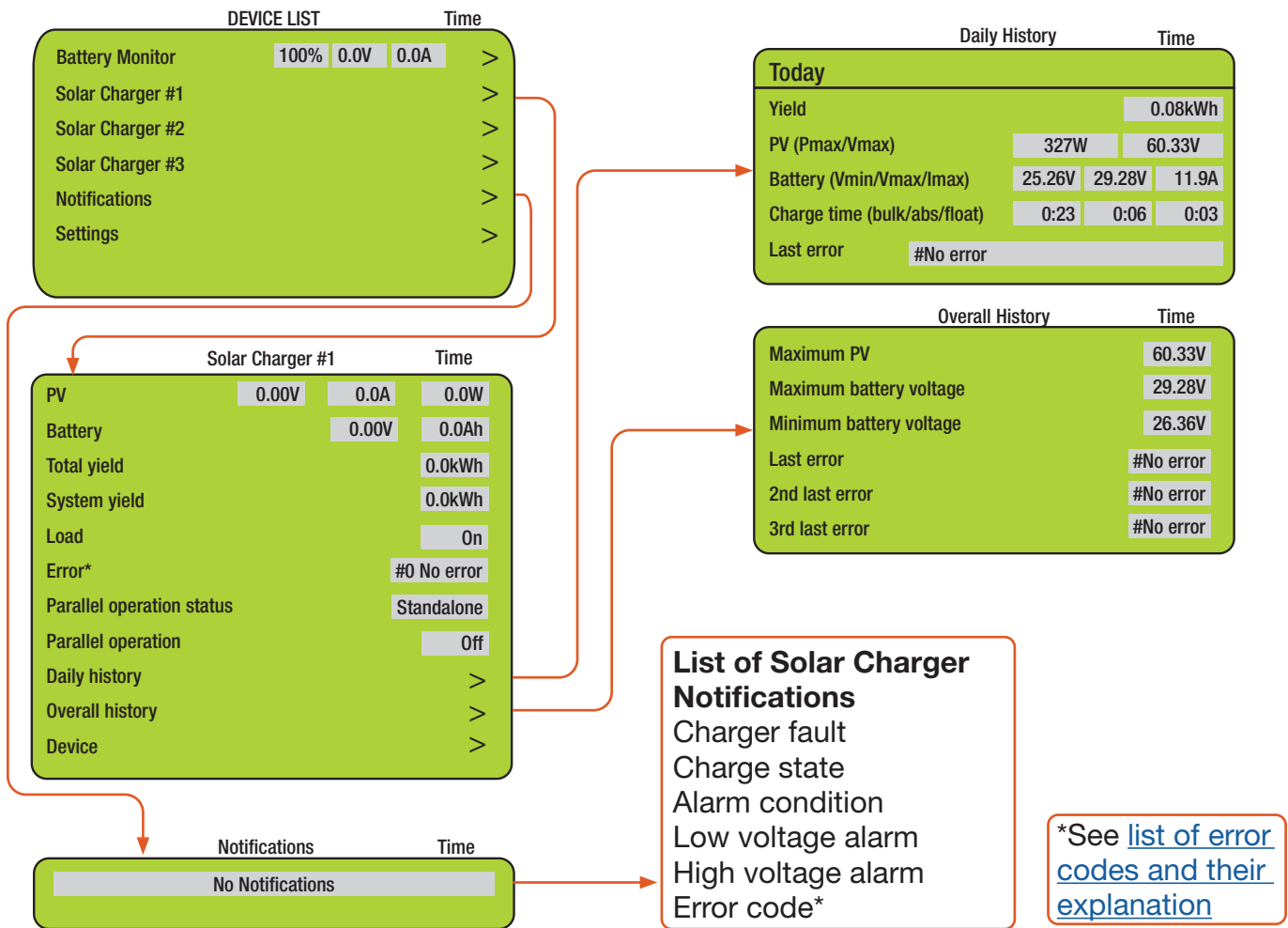

PV Power: Understanding Reported Values

The Power Hub solar charge controllers report the power they process to the user interface. Checking these readings often, over extended periods of time, will establish what is “normal” in the system and give the operator a greater ability to identify and correct deviations from “normal”.

Monitoring System Batteries: Current and Historical

Press the Menu button one time to display the device list. The window that will appear is illustrated below. The Battery Monitor will be the first device listed. Values for the current battery SOC, DC bus voltage, and current (amps) will appear in the fields on that line. Press the Select or Right button to open the Battery Monitor window to display current details about the batteries connected to the System. The temperature displayed here is the Power Hub internal temperature, not the temperature of the System batteries. Alarms and historical data related to the System batteries are found in the Alarms and History Menus.

As the System batteries approach a fully charged state, the charging current will approach zero (0) amps even if the sun is shining brightly and/or the generator is running. If this occurs, check the battery SOC to confirm that the batteries are nearing a full charge. If not approaching 100%, ensure the PV arrays are connected and functioning properly. Charging parameters can be changed if necessary. Please contact your FSR for assistance.

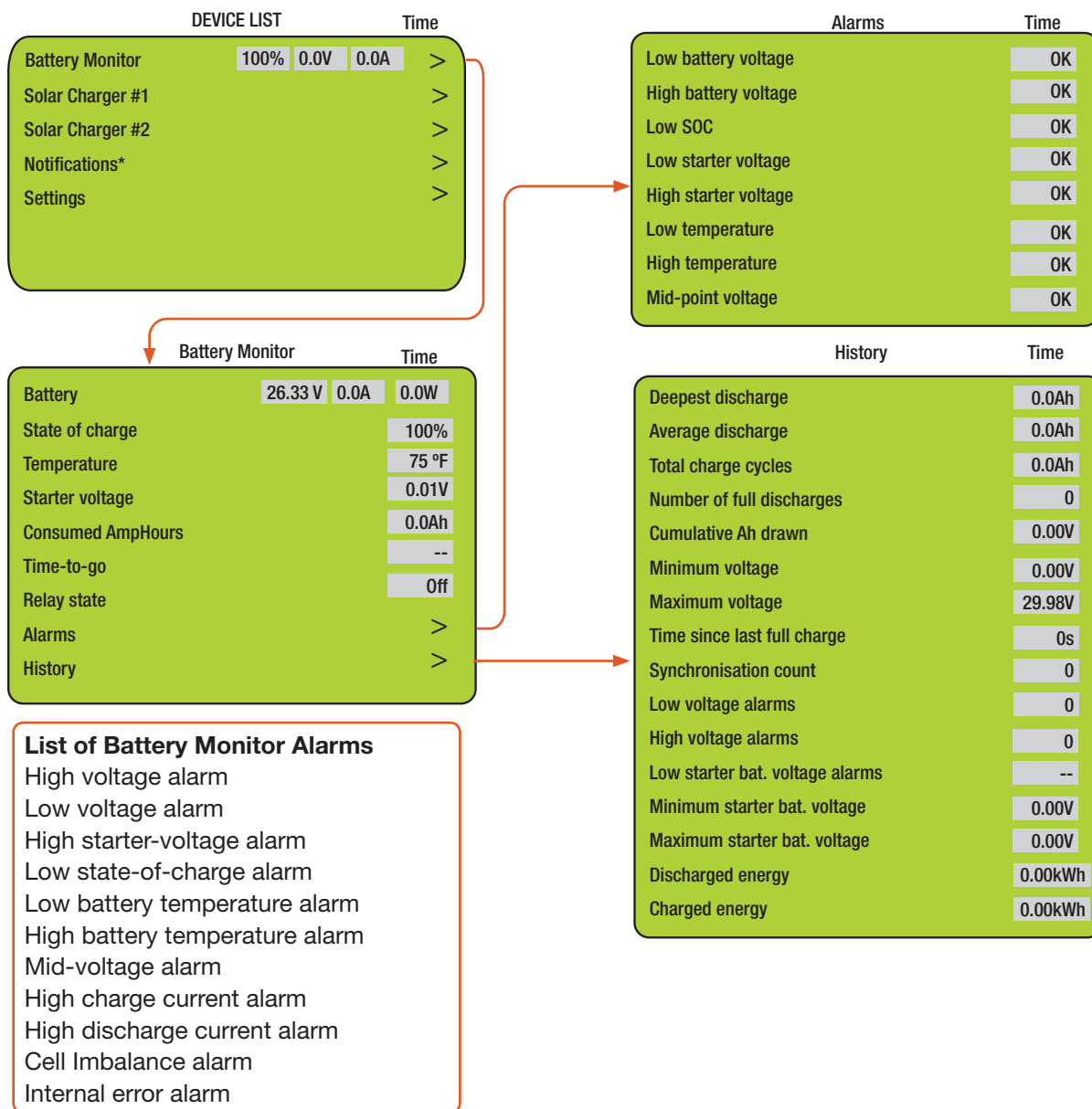

Battery Monitor: Understanding Reported Values

The voltage and current flowing out of the Power Hub (reported in the Battery Monitor submenu) are accurate in any System configuration. The SOC reported by the battery monitor is accurate when both batteries and loads are connected directly to the Power Hub as shown in Figure 20.

The battery SOC is calculated based on (a) the programmed amp hour (Ah) capacity of the system batteries and (b) measuring the amps that flow into and out of the battery over time (Ah counting). Measuring the battery SOC requires current to move in and out through a “metered” port: into the batteries from a charging source and out from the batteries to support loads.

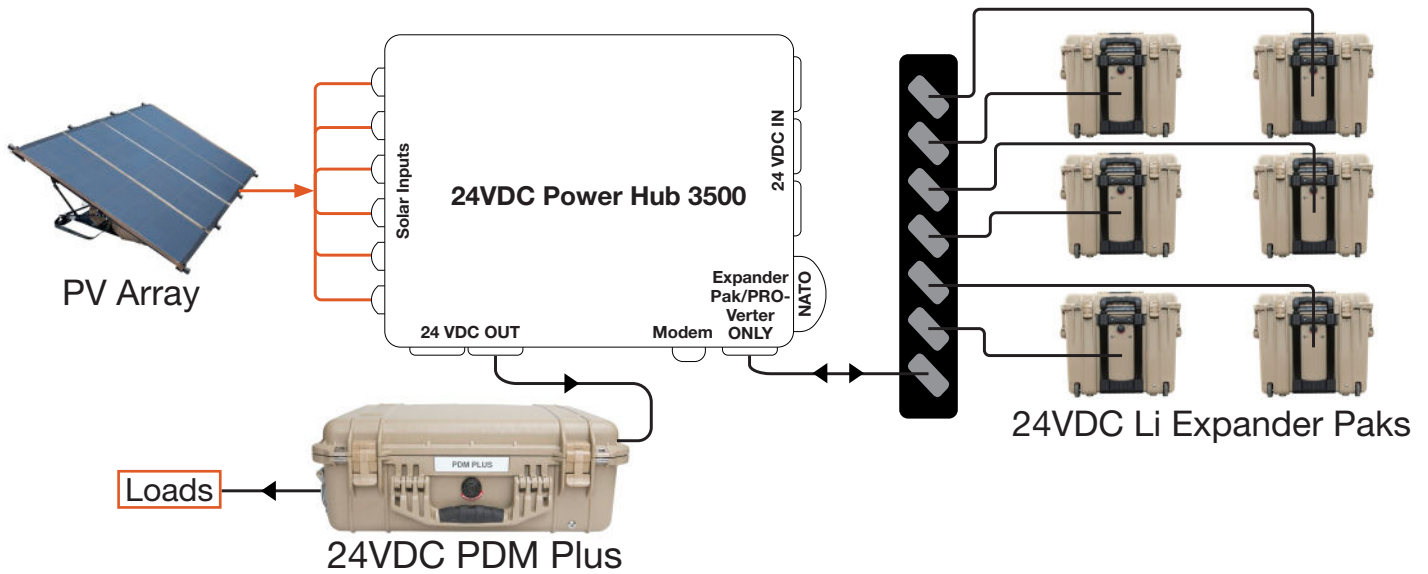

Figure 20. Power Hub as the primary power management device

If the Power Hub is connected to the system batteries indirectly, via another power management device such as a PRO-Verter (Figure 21) the Power Hub is no longer then primary Power Management component. In this case, the SOC reported by the PRO-Verter supersedes the SOC reported by the Power Hub because the energy stored in the batteries flows to the load via the metered port of the PRO-Verter and not the metered port of the Power Hub. In this configuration, the SOC reported by the Power Hub will report 100% when the system batteries become charged fully; the Power Hub SOC will remain at or near 100% until the power is cycled.

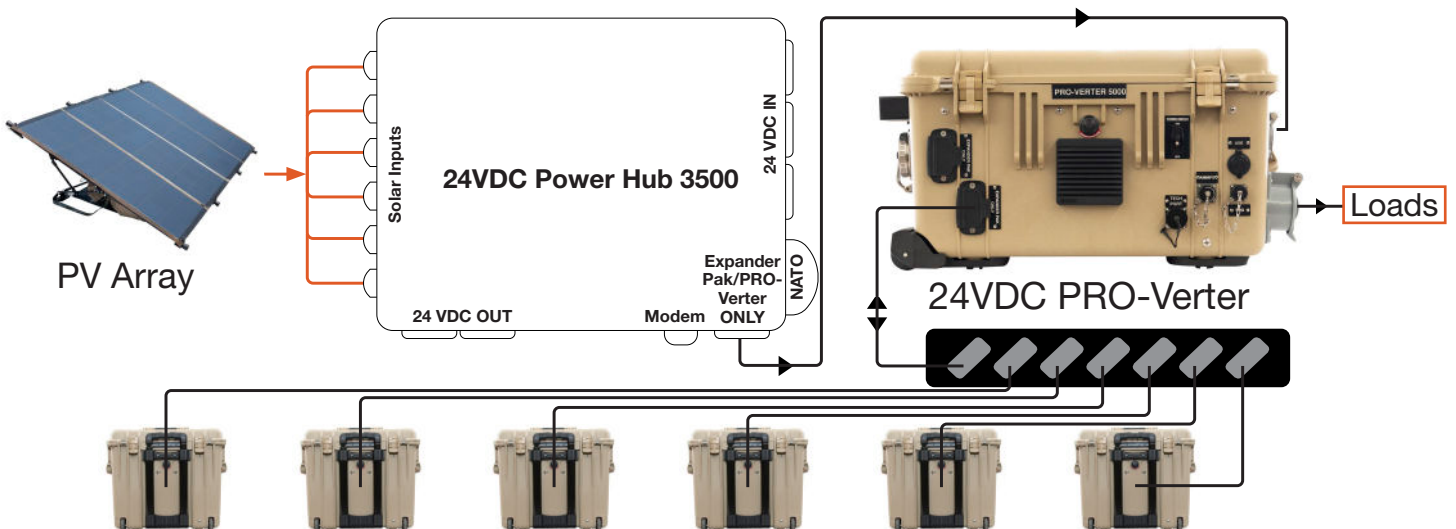

Figure 21. Power Hub as the secondary power management device

Heat and Derating

The function and efficiency of all electronic equipment is related to and dependent upon the temperature at which it is operating. All equipment performs optimally within a narrow temperature range and less so as the temperature exceeds the upper end of that range. PV panel output drops off significantly in high heat as well. The Power Hub generates heat as a by-product of processing incoming PV power. Under normal circumstances, the amount of heat generated in this way will not exceed the rated temperature for the Power Hub to function at its rated capacity.

Causes of Overheating

The two (2) most common reasons for the Power Hub to overheat are high ambient temperature and solar loading (heat accumulation due to the sun shining directly the Power Hub). These two factors work together to elevate the internal operating temperature to the point where the solar chargers may automatically derate or even temporarily suspend output to prevent damage to their internal electronics. The solar chargers are rated to provide full power up to 104 °F (40 °C). Performance of the Power Hub will decline (charging current reduced) as the temperature increases or is sustained above this value.

Note: The charging current reported by the Power Hub battery monitor will also approach zero (0) A as the batteries approach a fully-charged state.

Power Hub Internal Cooling

Thermostat-controlled, internal cooling fans turn on at ~104 °F (40 °C) to maintain the internal temperature within the optimal operating range. The fans are audible when operating. Clogged air intake filters can significantly exacerbate heat-related problems, so they should be cleaned as often as necessary to maintain maximum airflow. [Clean or replace the air filter](#) monthly, or more frequently if operating in very dusty environments. Do not operate the Power Hub in direct sunlight or directly on the ground. It should be placed in a shaded, well-ventilated location. Proper air filter maintenance and shading the Power Hub will help to ensure that the internal temperature does not reach critical levels.

Power Hub Internal Temperature Report

The Power Hub has a sensor that measures and reports the internal temperature. The internal temperature of the Power Hub (NOT the batteries) is reported in the Battery Monitor menu page. To access this and other battery-related data, press the Menu button to show the device list. Select/highlight “Battery Monitor” and either right-click or press the Select button to display.

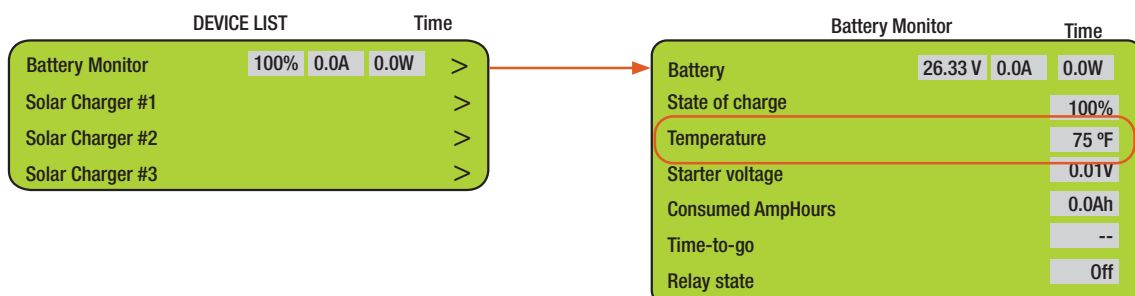
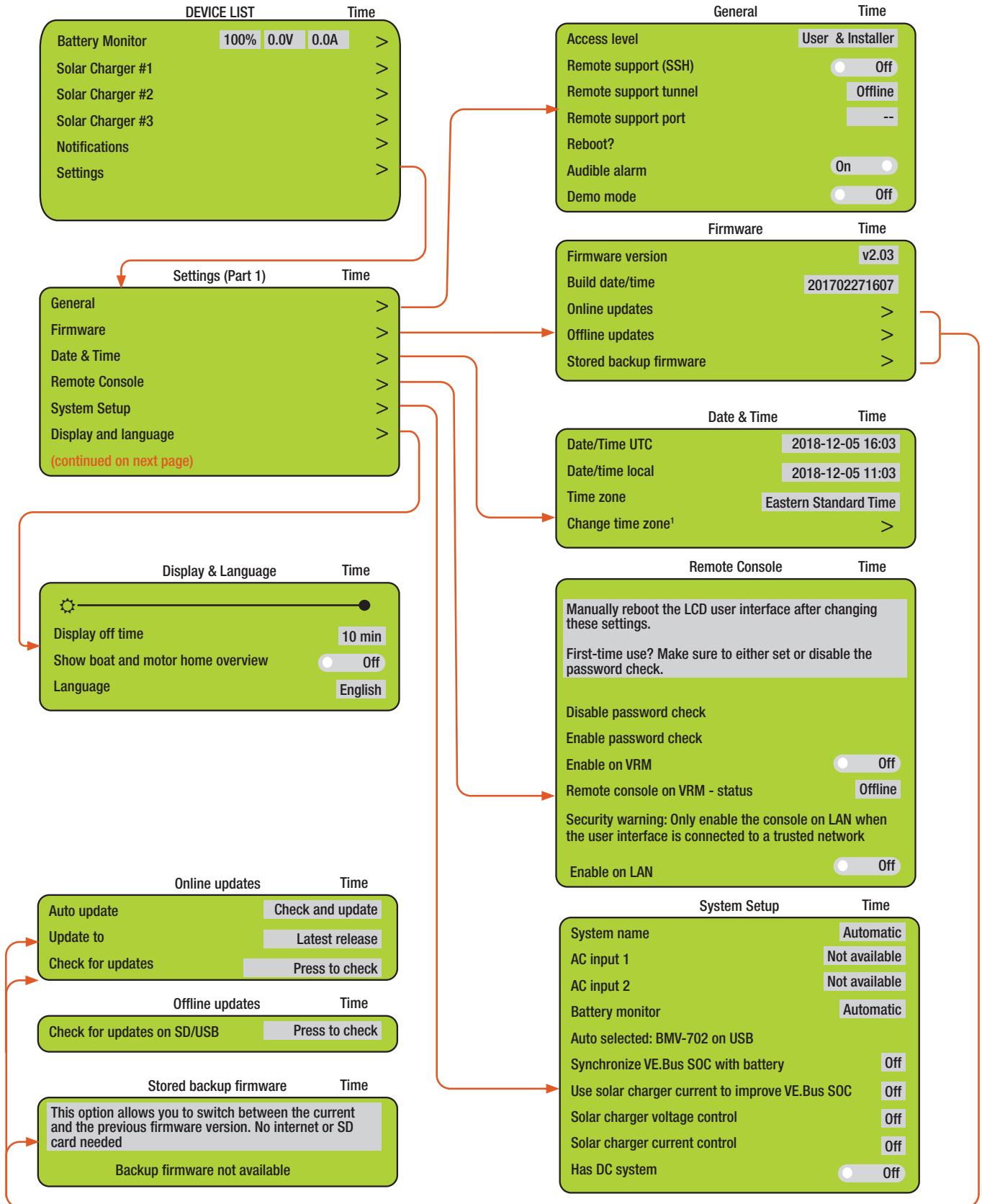
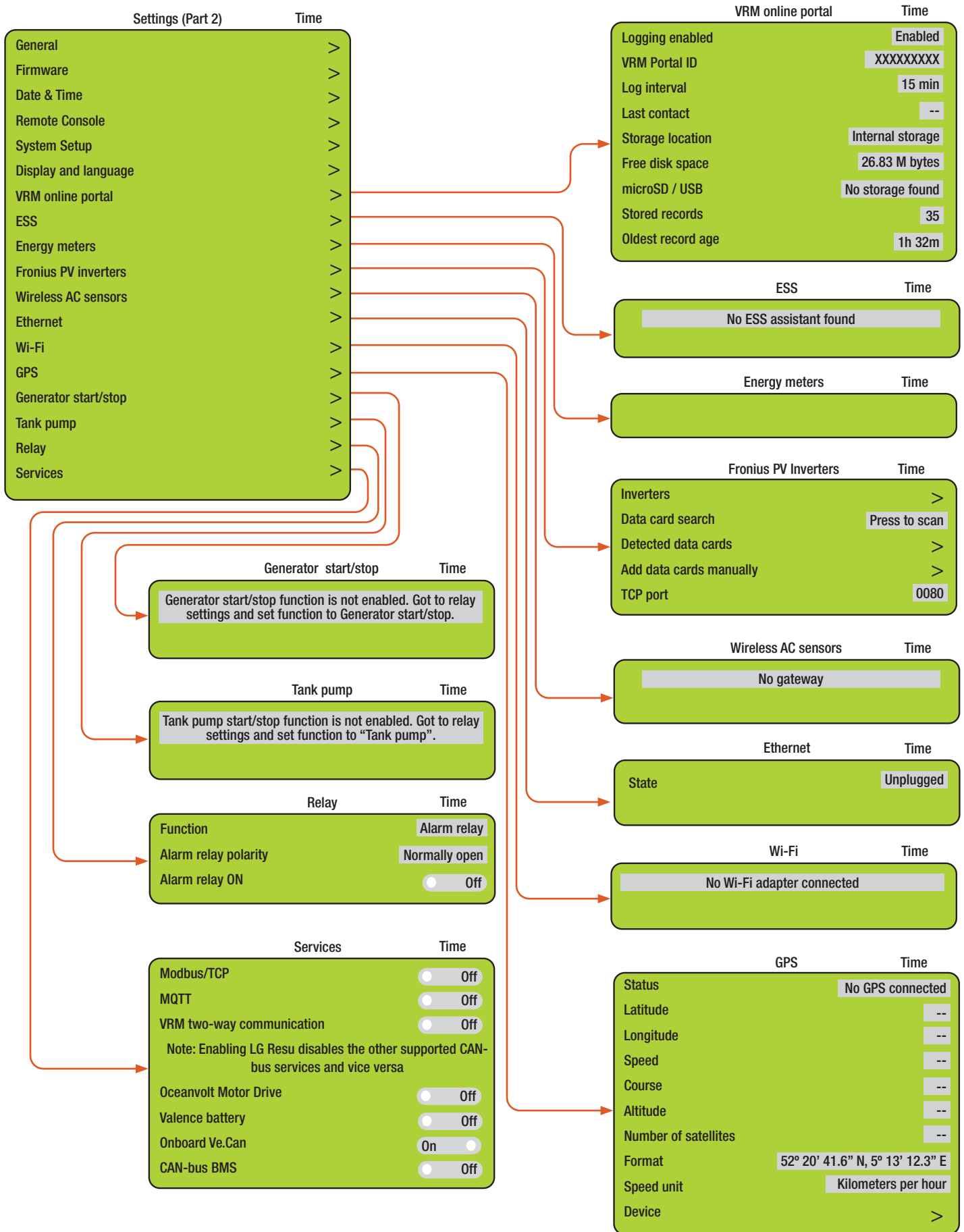

Figure 22. Power Hub internal temperature report on user interface

User Interface Settings Menus

Settings are accessed from the device list. The settings menus contain several parameters that may need to be changed during the course of normal operation. Many of the options are not relevant to the Power Hub.





Power Hub Stacking

All Solar Stik Systems are scalable, and the method used for scaling Power Management components is “Stacking”. Multiple Power Hubs can be stacked when conditions warrant. Stacking can be used when a greater contribution from PV is desired, and the PV rating exceeds the ability of a single Power Hub to regulate. (Figure 23)

The combined maximum **potential** power output from two (2) Power Hub 3500s is 7000 W in a stacked configuration. At 24 VDC, that equals 208 A of current, which roughly equals the 200 A max capacity of the Inter-Connect Cable. A maximum of six (6) 400 W PV arrays (~2500 W) may be connected to each of the two (2) Power Hubs to remain within the rated current capacity of a single Inter-Connect Cable in the configuration shown in Figure 23. Higher power configurations are possible with additional Inter-Connect cables and Strips.

Expansion of a system to include more solar than 4800 W of PV power is simple, but it must be done in a way that maintains the “balance” of all System components and circuits. Please contact your FSR for help with such an expansion.

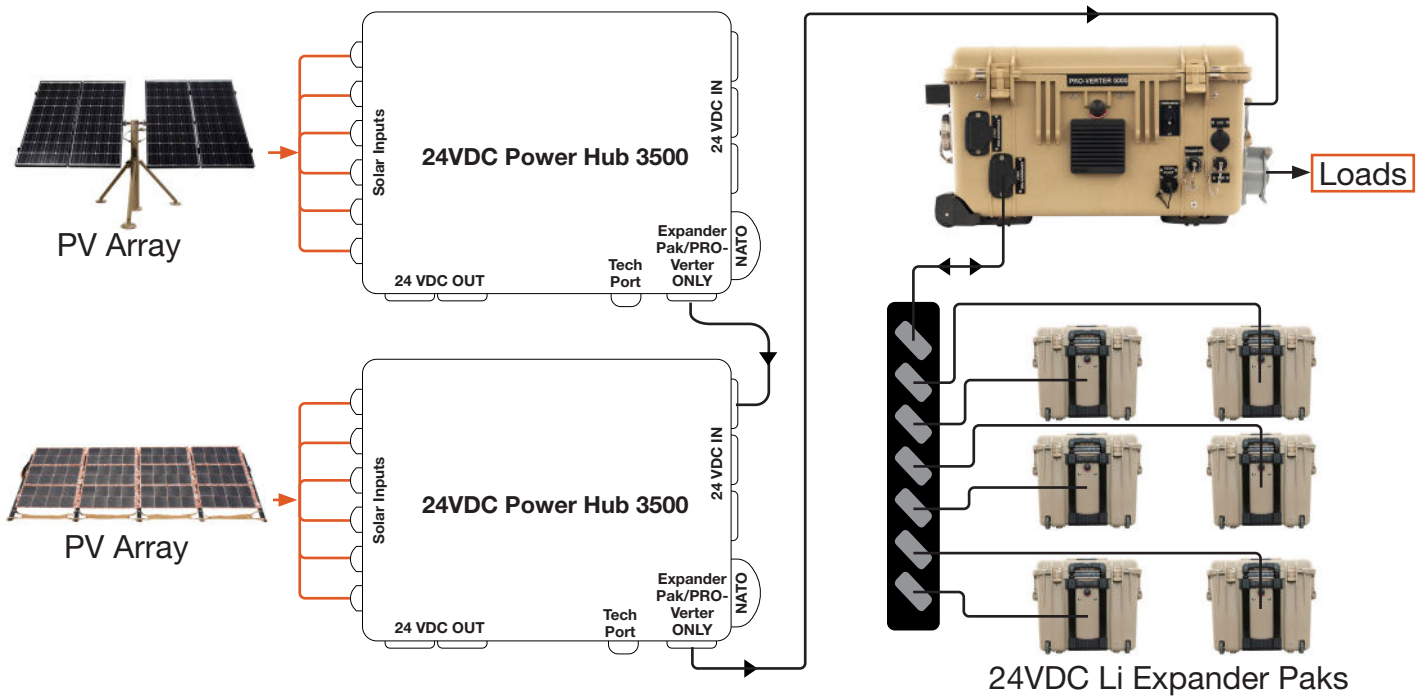

Figure 23. Stacking Power Hubs

Storing the Inter-Connect Cable

The 5' Inter-Connect cable can be coiled and stored using the connector on the Faceplate.

Note: These connectors are not electrically active.

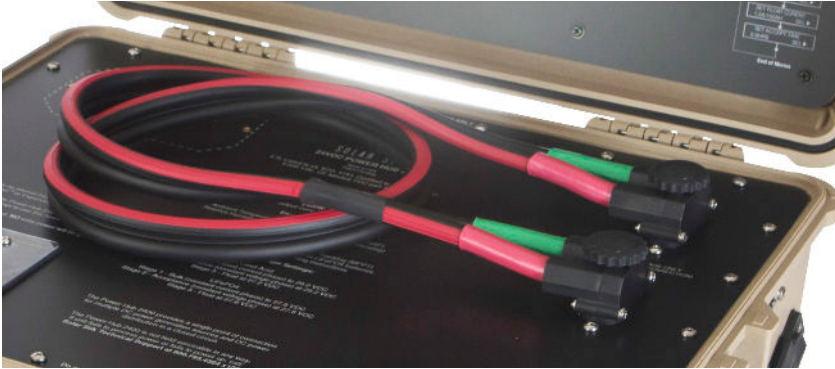

Figure 24. Inter-Connect Cable storage

Locking Component Cases to Prevent Tampering

The Power Hub 3500 can be secured with a padlock to deter tampering. Four (4) latches allow the case to be sealed to prevent damage to the internal components from environmental factors. Additionally, two (2) sets of steel-reinforced holes, one (1) in the lid and one (1) in the base of the case, flank the latches on the front of the case. A lock similar to the one shown in Figure 26 is recommended; not all locks are compatible.

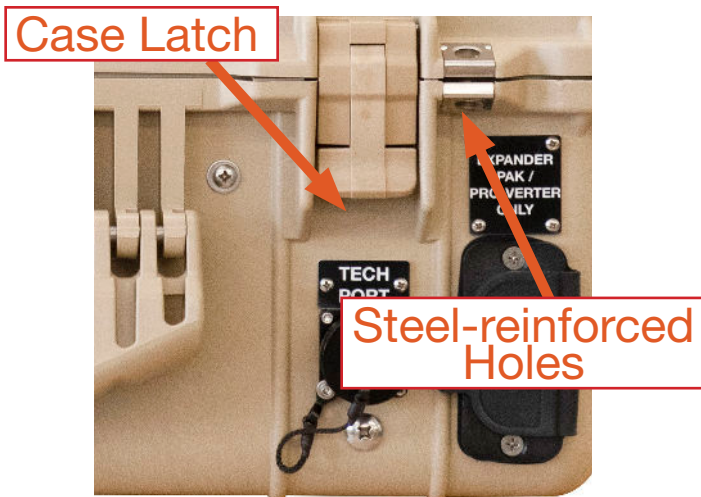

Figure 25. Steel-reinforced padlock holes



Figure 26. Lock securing Power Hub lid

Transporting the Power Hub

The Power Hub transports like a briefcase and is safe for all modes of transportation, including land, sea, and air. There are no transport restrictions.

Water Intrusion Remediation

If water intrusion is suspected, and the System is still functional, disconnect power sources entering the Power Hub from the most distant location possible, power down the System (turn off the power switches on all of the System components) and then disconnect the Power Hub from the System. Do not move or relocate what may be a flooded Power Hub.

Keep the Power Hub as level as possible to prevent the water inside from accumulating at one end or the other and submerging the internal electronics. Remove the screw from the drain hole at the bottom edge of the case. If water flows out of the drain hole after removal of the plug, let it flow until it stops. Then slightly and slowly tilt the case toward the drain hole to remove any remaining water. Continue to increase the angle of the Power Hub slowly until no more water drains from the hole. After the water has been drained, remove the Faceplate. Place the Power Hub in the most dry environment possible for a time long enough that any remaining moisture inside will dry. When it is dry, reintegrate the Power Hub to the System and test it to determine if it is still functional.

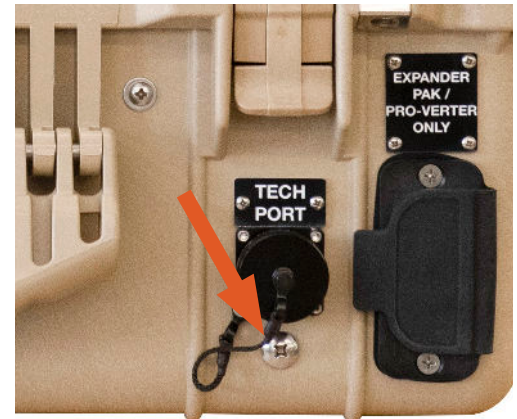

Figure 27. Drain plug screw located under the TECH PORT

TROUBLESHOOTING PROCEDURES

Power Hub Will Not Power Up

If the Power Hub 3500 is not powered up, it probably is not connected to an active 24 VDC battery and/or there is no PV input. The LCD user interface will power up and be navigable when connected to either of these power sources. Power from PV arrays will charge batteries once the voltage from the arrays is 5 volts greater than the battery voltage then continue charging as long as the voltage from the PV arrays is 1 volt higher than that of the batteries.

Performance Issues, Causes and Solutions

Table 1. Symptoms and Solutions for the Most Common Power Hub Issues

Symptom	Possible Cause(s)	Solution
Battery SOC displays "--".	Battery not fully charged for an extended period or has not been cycled enough times for the user interface to calculate SOC.	Try to charge the battery fully often. Refer to the setup diagram to make sure that the System is assembled correctly.
Battery SOC seems inaccurate	Power Hub is not the primary power management device.	Normal operation. Read battery SOC from primary management device (e.g., PRO-Verter)
Not registering charge current with panels operating in sun	<ol style="list-style-type: none"> Power Hub overheated Batteries fully charged (29.0 VDC or near to that) 	<ol style="list-style-type: none"> Check internal temperature and "battery" temperature on user interface. Derating begins at 104 °F; diminishing power as temp approaches 140 °F. Check for dirty, blocked air filters. Shade the Power Hub to reduce solar loading. Ensure that the internal cooling fans are operating (audible when operating). Normal operation.
LCD inoperative	<ol style="list-style-type: none"> No power to the Hub The LCD screen is overheated/sunlight exposure 	<ol style="list-style-type: none"> Check connections and make sure batteries are active. Close lid and allow Power Hub to cool down.

Note: The battery SOC and related readouts on the Power Hub 3500 LCD user interface are precise ONLY if the batteries are connected directly to the Power Hub 3500. If the batteries are connected to the PRO-Verter (indirectly to the Power Hub 3500), then information about the battery SOC and other parameters should be obtained from the PRO-Verter user interface or the optional RMK.

Data Logging and Remote Monitoring

Performance and Troubleshooting

The Power Hub user interface monitors and reports Power Hub-,PV-, and battery-related data in real time. These data are also stored in the user interface and provide a historical record of these events over time.

A complete list of the historical information available for PV power performance is found in [Monitoring PV Power: Current and Historical](#). The list for battery-related information is found in [Monitoring System Batteries: Current and Historical](#). Understanding the battery-related information will depend on how the Power Hub is being used. Please see the [Battery Monitor: Understanding Reported Values](#) section. [Error codes](#) related to the solar charge controllers and notifications are accessed in: Menu>Device List>[Notifications](#).

These historical records can assist in troubleshooting and maintaining peak performance of the Power Hub and connected components such as PV arrays and batteries.

Performance, both current and historical can be monitored offline or online using a third-party application called the Victron Remote Monitoring (VRM) Portal. These methods are described in the following sections.

Data Storage and Retrieval

The built-in nonvolatile storage can contain 48 hours worth of data. To extend this period, insert a micro SD card into the port on the bottom side of the user interface (Figure 28). The user interface will automatically transfer any data that may reside on the internal storage to it and will start using this external memory as backlog buffer.

A data logging interval of once per minute, will require about 25 MB per month, depending on the number of connected products. So with a 1 GB micro SD card, about 3 years of data can be stored. In other words, any micro SD card should be sufficient to store the 6 months of data.



Figure 28. Micro SD card port location

When the storage device is full, no more data will be logged. This is due to the nature of Sqlite (a software library and file type) files. Removing data from the Sqlite database doesn't free up usable disk space, and because of internal fragmentation, it doesn't guarantee more data storage.

If the Power Hub is connected to the internet (Tech Port) past and current data stored on a microSD card can be uploaded to VRM Portal (See [Remote Monitoring](#)). If the internet connection is intermittent data stored on the microSD card can be automatically uploaded to the VRM Portal each time the connection is reestablished. Instructions for accessing the VRM Portal are provided in [Remote Monitoring](#) on the following page.

If the Power Hub is not connected to the internet, the user can upload the data backlog manually to the VRM Portal by using the following protocol. The first step is to use the Settings window to eject the storage; don't just remove the SD card (Settings > VRM online portal > Micro SD / USB). The storage device can then be removed from the user interface and inserted into a computer or laptop; the data file on it can be uploaded on the VRM Portal with the 'Upload CCGX File' option.

It's important to know that when the micro SD card is reinserted, the existing buffer—including its data—is used again. This allows for removing the micro SD card temporarily for whatever reason, but this also means when the data file has been uploaded to VRM, it needs to be renamed or cleared from the micro SD card before reinserting, otherwise the data will be transmitted again, sooner or later, online or offline.

MicroSD Card Formatting

Micro SD cards must be formatted as FAT12, FAT16, or FAT32 file systems—not as exFAT or NTFS.

SD- and SDHC-type micro SD cards of 32 GB capacity and smaller are sold containing FAT12, FAT16, or FAT32. They can be used without a problem, unless they are subsequently reformatted to a different file system.

SDXC-type micro SD cards with greater than 32 GB capacity are often formatted with exFAT and therefore cannot be used with the user interface without reformatting and possibly repartitioning.

Remote Monitoring

When the Power Hub is connected to the internet using the Tech Port, both current and historical performance data from the Power Hub can be monitored remotely. The information provide by the VRM Portal and how to use that information is describe in Performance Remote monitoring requires access to the VRM Portal. Instructions for accessing the VRM Portal are provided below.

Getting Started

The process is straight forward and self guiding. First, create a VRM user account. And after that the installation, needs to be paired with that user account. It is possible to pair one installation to multiple user accounts.

Requirements

- A computer connected to the internet
- The VRM Portal ID, which uniquely identifies your system
- Power Hub LCD user interface: The VRM Portal ID can be found in the menu Settings > VRM Logger. It looks like this: be300d83ff04.

Step 1. Create a user account

1. Go to <https://vrm.victronenergy.com>.
2. Click 'Register for Free'.
3. Complete all the requested information.
4. A confirmation email will arrive to the registered account with a link to activate your account.

Account creation is now finished. Click 'Add Installation' to continue pairing the Power Hub to this user account. Each step will be prompted.

Step 2. Add the Power Hub to the user account

Note: Make sure the Power Hub has already started communicating with the VRM Portal. Or, in case it is an off-grid installation where an SD card is used, first upload the data file.

Adding a Power Hub "Installation" is only possible after the VRM Portal has received the first data transmission from the Power Hub user interface.

Steps to add an installation:

1. Select the product you want to add.
2. Enter the IMEI or MAC Address number for the color control/User Interface.
3. Click 'Add' and your device is now paired with your VRM user account.

Note: In case you are the first user to add this installation to your account, you will automatically have Admin rights for this installation. Any subsequent users who add this installation to their account will become a normal user without the ability to change any settings. An Admin user can assign Admin rights to other users on the Settings page.

The Dashboard screen will appear with intuitive, interactive elements.

Solar Charge Controller Error Codes

Detailed error codes can be read with a LCD user interface. **The vast majority of these errors will not be encountered when the Power Hub is operating in concert with other HPS components. All possible error codes are included for reference purposes.**

Err 2 - Battery voltage too high

This error will auto-reset after the battery voltage has dropped. This error can be due to other charging equipment connected to the battery or a fault in the solar charge controller. This error can also occur if the battery voltage is set to a lower voltage than the actual battery voltage (e.g., 12 VDC for a 24 VDC battery).

Err 3, Err 4 - Remote temperature sensor failure

Check if the T-sense connector is properly connected to a remote temperature sensor. Most likely cause: the remote T-sense connector is connected to the BAT+ or BAT- terminal. This error will auto-reset after proper connection.

Err 5 - Remote temperature sensor failure (connection lost)

Check if the T-sense connector is properly connected to a remote temperature sensor. This error will not auto-reset.

Err 6, Err 7 - Remote battery voltage sense failure

Check if the V-sense connector is properly connected to the battery terminals. Most likely cause: the remote V-sense connector is connected in reverse polarity to the BAT+ or BAT- terminals.

Err 8 - Remote battery voltage sense failure (connection lost)

Check if the V-sense connector is properly connected to the battery terminals.

Err 17 - Controller overheated despite reduced output current

This error will auto-reset after the solar charge controller has cooled down. Check the ambient temperature and check for obstructions in the ventilation filters. Shade the Power Hub.

Err 18 - Controller over-current

This error will auto-reset. If the error does not auto-reset disconnect the solar charge controller from all power-sources, wait 3 minutes, and power up again. If the error persists the solar charge controller is probably faulty. A cause for this error can be switching on a very large load on the battery side.

Err 20 - Maximum Bulk-time exceeded

This error can only occur when the maximum bulk-time protection is active. This error will not auto-reset. This error is generated when the battery-absorption-voltage is not reached after 10 hours of charging.

Note: This protection is default disabled in all solar charge controllers. Do not enable it.

Err 21 - Current sensor issue

This error will not auto-reset.

Disconnect all wires, and then reconnect all wires. Also, make sure the minus on the MPPT solar charge controller (PV minus/Battery minus) is not bypassing the solar charge controller.

If the error remains, please contact your FSR.

Err 26 - Terminal overheated

Power terminals overheated, check wiring, including the wiring type and type of strands, and/or fasten bolts if possible.

This error will auto-reset.

Err 28 - Power stage issue

This error will not auto-reset.

Disconnect all wires, and then reconnect all wires. If the error persists the solar charge controller is probably faulty. Contact FSR.

Err 33 - PV over-voltage

This error will auto-reset after PV-voltage has dropped to safe limit. This error is an indication that the PV-array configuration with regard to open-circuit voltage is critical. Check the PV panel spec, configuration, and if required, re-organise panels.

Err 34 - PV over-current

The current from the PV-panel array has exceeded 75A. This error could be generated due to an internal system fault. Disconnect the Power Hub from all power-sources, wait 3 minutes, and power-up again. If the error persists the controller is probably faulty, contact your FSR.

Err 38, Err 39 - PV Input shutdown

To protect the battery from over-charging the panel input is shorted.

Possible reasons for this error to occur:

- There is another device connected to the battery, which is configured to a higher voltage.
- The battery is disconnected using a manual switch. Ideally the charger should be switched off before disconnecting the battery, this avoids a voltage overshoot on the charger output. If necessary the voltage trip-level for the PV Short protection can be increased by raising the Equalization voltage set-point (note: equalization does not have to be enabled in this case).

Error recovery:

- Error 38: First disconnect the PV panels and disconnect the battery. Wait for 3 minutes, then reconnect the battery first and next the panels.
- Error 39: The Power Hub will automatically resume operation once the battery voltage drops below the max charge level for 1 minute.

If the error persists the one or more solar charge controller is probably faulty. Contact FSR.

Information 65 - Communication warning

Communication with one of the paralleled controllers in the Power Hub was lost. To clear the warning, cycle the power to the Power Hub.

Information 66 - Incompatible device

The controller is being paralleled to another controller that has different settings and/or a different charge algorithm.

Make sure all settings are the same and update firmware on all solar charge controllers in the Power Hub to the latest version

Err 67 - BMS Connection lost

The solar charge controller is configured to be controlled by a BMS, but it does not receive any control messages from a BMS. The charger stopped charging, as a safety precaution.

Check the connection between the charger and the BMS.

How to reset the solar charge controller to de-couple it from the BMS

When the charger needs to operate in stand-alone mode again, not controlled by a BMS, it needs to be reset:

- Solar chargers, go into the setup menu, and change setting 'BMS' from 'Y' to 'N' (setup item 31).
- Reset the solar charge controllers to factory defaults, and then reconfigure it.

Note that solar chargers automatically configure themselves to be BMS-controlled when they are connected to one, either directly or via the LCD user interface. The Power Hub was programmed to work independently from a BMS.

Err 114 - CPU temperature too high

This error will reset after the CPU has cooled down. If the error persists, check the ambient temperature and check and or clean the air filters. Shade the Power Hub to reduce solar loading.

Err 116 - Calibration data lost

If the unit does not work and error 116 pops up as the active error the unit is faulty, contact your FSR.

If the error is only present in the history data and the unit operates normally this error can be ignored safely. Explanation: when the units power up for the very first, it does not have calibration data and an error 116 is logged.

Err 119 - Settings data lost

The Power Hub cannot read its configuration, and stopped. This error will not auto-reset. To get it working again:

- First, restore it to factory defaults. Contact your FSR for the values.
- Disconnect the Power Hub from all power-sources, wait 3 minutes, and power up again.
- Reconfigure the Power Hub.

MAINTENANCE INSTRUCTIONS

Preventive Care and Maintenance

Note: The function and efficiency of all electronic equipment is related to and dependent upon the temperature at which it is operating. It performs optimally within a narrow temperature range and less so as the temperature falls outside of that range. **Heat will cause the Power Hub to derate.** Please use the following measures to mitigate against heat and other environmental effects:

- Shade the Power Hub from direct sun exposure and shelter it from the elements as much as possible.
- Keep the case lid and Inter-Connect covers closed to prevent water/dust intrusion.
- Check the integrity of electrical connectors on a monthly basis.
- Turn off electrical appliances when they are not in use. This will save power, allowing more power to be available when it is needed.
- Clean the air filters of the Power Hub air intake vents monthly. Wash them with water, dry them thoroughly, and place them back in the intake vents. The filters must be cleaned more frequently when high winds are frequent and particulate levels are high. See below.

Cleaning Power Hub Filters

The air intake vent and filter are on the back of the Power Hub. The louvered vent cover is secured by two (2) cross tip screws, one on each side. A fine cross tip screwdriver or angle driver will be required to remove the screws (Figure 29A). After exposing the filter (Figure 29B), lift it from the vent and wash thoroughly with water, dry thoroughly and reinstall (Figure 29C). **IF FILTER IS DAMAGED REPLACE IT INSTEAD.** Ensure the leading edge of the louvers are facing downward.



Figure 29. Cleaning the air intake filter

SUPPORTING INFORMATION

Using the Power Hub to Monitor PV Array Performance

Failure of a single PV panel or array may not be noticed during normal operation if monitoring only the total/cumulative solar output current from multiple arrays in the pages menu of the LCD user interface.

PV array output fluctuates due to changing environmental conditions. PV power generation can degrade as the panel temperature rises, and the failure of an entire PV array may occur if a portion of a single panel is shaded. It is important to monitor the output of each solar charger independently from the device list to ensure the system is operating at its best.

Assessing PV Array Performance

The amount of power that is produced by a PV panel depends primarily on two operating conditions:

- Direct sunlight onto the PV cell
- Temperature

MPPT charge controllers optimize the power production based on two factors:

- Available PV (solar) power
- Battery state of charge (SOC)

Solar array output fluctuates due to changing environmental conditions. PV generation can degrade as the panel temperature rises, and the failure of an entire solar array may occur if a portion of a single panel is shaded. It is important to occasionally monitor the DC values at each charge control unit in the Hub.

The DC readings should be approximately the same for every PV array across all charge controls.

Troubleshooting Individual PV Arrays Using the Power Hub User Interface

Failure of a single solar panel or solar array may not be noticed during normal operation if monitoring only the total solar output current from multiple arrays in the main menu of the LCD User Interface.

If using a single PV array, the failure of a single (1) solar panel may cause the entire solar array to appear failed when the solar panels are wired in series. The output from the entire solar array will be zero (0), and therefore the current of a single (1) charge unit will be significantly lower.

If multiple PV arrays are connected and have equal exposure to sunlight, then the output current from each PV array should be approximately the same. The output of individual arrays can be monitored independently at the User Interface.

To identify suspect arrays responsible for the decrease in current in that charge unit:

- Disconnect all but one PV array and view the performance metrics reported by the user interface.
- Cycle each PV array onto the Hub at the same connection, making note of the performance for each panel.

Some deviation between multiple panel performances is acceptable. If there is a significant delta between two or more arrays, it is likely that the arrays have a failed cell or other mitigating factor that should be investigated. Refer to the individual PV array manual or the System manual for further troubleshooting steps.

Specifications

General	
Operating Voltage	20–30 VDC programmable
User Interface	LCD and push button menu controls
Internal Cooling	Forced convection with (2) internal fans
Case	Pelican 1600
Warranty	1-year materials and workmanship

Charge Controller Specifications (@77 °F/25 °C)	
Maximum PV Input Voltage	100 VDC
Maximum PV Input Current	100 A (@ 24 V nominal)
Maximum PV Power	1166 W per charge controller, 3500 W total
Efficiency	98% (typical)
Battery Charging	29.0 VDC (programmable).
Charge Control Method	Maximum Power Point Tracking (MPPT)

Safety	
Circuit Protection	Charger protected against reverse polarity and transient voltage surges

Connections	
Input(s)	<ul style="list-style-type: none"> • (6) 24 VDC 30 A (per charge unit) Solar inputs (Amphenol bayonet CB2-22-2SC) • (3) 24 VDC 100 A (total) Inter-Connect* (regulated)
Output(s)	<ul style="list-style-type: none"> • (1) 24 VDC 100 A PRO-Verter/Expander Pak Inter-Connect* • (1) Remote Monitoring (RJ45)
Input/Output(s)	<ul style="list-style-type: none"> • (2) 24 VDC 100 A load/bus Inter-Connect* • (1) NATO receptacle

Environmental	
Operating Temperature	30 °C to + 60 °C (-22 °F to +140 °F) Full rated output to 40 °C (104 °F)
Operating Humidity	95% RH non-condensing

Weights and Dimensions (L x W x H)	
Weight	40.6 lb (18.4 kg)
Dimensions	24.39 x 19.36 x 8.79 in (62.0 x 49.2 x 22.3 cm)

Includes	
(1) 5-foot Inter-Connect Cable	

Inter-Connect Cable can be stored inside case
*Deltran 224-0061-BK

ABOUT SOLAR STIK, INC.



SOLAR STIK®

Mission Statement

Saving lives across the globe through innovative power solutions.

STIKopedia

[STIKopedia](#) is a compilation of everything you would ever want to know about portable Hybrid Power Systems, including the philosophy and mechanics of high-efficiency circuits, and the individual technologies used to create them.

Solar Stik Training and Education

- **Solar School (St. Augustine, FL)** provides an introduction to the design and support of small-scale, renewable-energy, power generation systems, with detailed explanation of system components. Advanced configuration options with hands-on deployment of actual systems will enhance student understanding.
- **Solar Stik New Equipment Training (on site)** teaches Hybrid System configuration options with hands-on deployment of actual systems to enhance student understanding.

Solar Stik Training Courses are tailored to the specific needs of the students. To schedule Solar Stik Training or to learn more about the curriculum, please contact us.

Contact

Tech Support (24/7)

(800) 793-4364 x102

Tech Support (Outside of the US) (24/7)

+1 (904) 808-0510 x102

Address

Solar Stik, Inc.
13 N Leonardi Street
Saint Augustine, Florida 32084

Website

www.solarstik.com

Trademarks and Logos are the property of Solar Stik, Inc. unless otherwise noted.

This manual is subject to revisions without prior notice.

© 2023 Solar Stik, Inc.

All Rights Reserved.