



SOLAR STIK®

OPERATOR AND MAINTENANCE MANUAL FOR THE 24VDC LI EXPANDER PAK 2400

P/N 21-0202303



DISTRIBUTION STATEMENT A. Approved for public release; distribution is unlimited.

Version 2.0

Updated: 20191105

Contents

GENERAL INFORMATION, PRINCIPLES OF OPERATION, AND EQUIPMENT DESCRIPTION

Energy Storage Modules - An Introduction	5
Important Product Safety Information and Instructions	6
Safety Information Labels	6
Limitations on Liability	6
Fire Hazard	7
Recommended Fire Extinguisher	7
Electric Shock Hazard	8
Environmental and Handling Precautions	9
Water	9
Impact	9
Dust	9
Heat	9

PRINCIPLES OF OPERATION – THE EXPANDER PAK

Advanced Battery Management System (BMS)	10
The Inter-Connect System	11
Optimizing the Battery Configuration	13
Determining Proper Battery Capacity for a System	13
Scaling Methods	14
Keys to Expander Pak Performance	14
Equipment Description	15
Data Plate (D-Plate)	17

OPERATOR INSTRUCTIONS

Connect the Inter-Connect Cable to the Expander Pak	18
Connect Expander Paks to Inter-Connect Strip	18
Connect Expander Paks to Power Management	19
Activate Expander Pak and Check Battery Status	19
Monitoring Battery Status	20
Alternative Methods of Recharging the Expander Pak	21
Recharging Voltage	21
Correct Polarity	21

MAINTENANCE INSTRUCTIONS

Expander Pak Storage	22
There is a simple rule to remember about maintaining the Expander batteries:	22
In-storage Preventive Maintenance Checks and Services	23

TROUBLESHOOTING PROCEDURES

Resolving Red-flash Battery Status LED Conditions	24
Background	24
Instructions	24
Procedure for Recovering Li Expander Pak from Red-flash Condition	25
Resolving No-light LED Conditions	26
Background	26
Instructions	26

MAINTENANCE INSTRUCTIONS

Preventive Care and Maintenance	29
Water Intrusion—Prevention and Remediation	29
Service Parts	30
Battery Service Kit.	30
MKM Replacement/Maintenance Record.	30

SUPPORTING INFORMATION

24VDC Li Expander Pak 2400 Upgrade Product Change Notice.	31
V0001 and V0002 24VDC Li Expander Pak 2400s	33
MKM BMS Firmware Update	35
Li Expander Pak Transport	37
Air	37
Ground.	37
Disposal – LiFePO₄ Battery	38
Technical Specifications	39
Accessories.	39

ADDENDUM – Understanding Li Expander Paks

ABOUT SOLAR STIK, INC.

Contact	45
--------------------------	-----------

List of Figures

Figure 1. Inter-Connect plug.....	12
Figure 2. Connecting Li Expander Paks using Inter-Connect Strips and Inter-Connect Cables.....	14
Figure 3. Placards on the front of the 24VDC Li Expander Pak 2400	15
Figure 4. Labels on the top exterior of the 24VDC Li Expander Pak 2400.....	16
Figure 5. 24VDC Li Expander Pak 2400 D-Plate	17
Figure 7. Connecting and stacking multiple Expander Paks.....	18
Figure 6. Connecting Inter-Connect Cable to Expander Pak.....	18
Figure 10. Connecting Expander Paks to Solar Stik power management	19
Figure 9. Li Expander Pak battery status indicator	19
Figure 8. Li Expander Pak power switch.....	19
Figure 11. Battery Status LED color and Li Expander Pak voltage relationship	20
Figure 12. 24VDC Li Battery Maintainer with Inter-Connect Plug	21
Figure 15. Screw locations on top of Li Expander Pak	26
Figure 13. No-light LED condition	26
Figure 14. Measuring voltage across terminals of Inter-Connect port	26
Figure 18. Measuring voltage across wires	27
Figure 16. BMS LED indicator light	27
Figure 17. Inspecting Molex connector	27
Figure 19. Momentary switch fasteners	28
Figure 20. Performing continuity test	28
Figure 21. Li Expander Pak drain plug location.....	29
Figure 22. Opening the Expander Pak Case Lid	29
Figure 23. MKM URB0014 Battery.....	30
Figure 24. Example V0002 designation.....	31
Figure 25. Example VF002 designation.....	32
Figure 26. V0001 and V0002 Battery Status LED placards.....	33
Figure 27. V0001 and V0002 power switch placards.....	33
Figure 28. V0001 and V0002 product and serial number placards	34
Figure 29. Removing Tech Port cover	35
Figure 30. MKM BMS Firmware Loader	35
Figure 31. Firmware Loader connected to the MKM Tech Port	36

List of Tables

Table 1. Battery Status LED Color and Corresponding Condition	19
Table 2. In-storage Preventive Maintenance Checks and Services	23

Revision History

Section	Page(s)	Description	Date
		First published	12 Apr 2018
	5, 10, 13	Introductory information	01 Nov 2019

GENERAL INFORMATION, PRINCIPLES OF OPERATION, AND EQUIPMENT DESCRIPTION

Energy Storage Modules - An Introduction

Energy Storage Modules (ESMs or “batteries”) serve as the foundation for every Hybrid Power System (HPS). When ESMs are employed in a power system, they can serve many different functions:

- Backup power for critical loads when the primary power source fails
- Power when periods of “silent” operation are critical
- Use of renewable power generation is desirable
- Less reliance on grid-utility power is desirable (peak shaving)

ESMs are also critical to the operation of the Inter-Connect network. They open the system architecture to allow multiple technologies to operate in concert. When functioning ESMs are congregated within the Inter-Connect Circuit, their collective voltage is what allows the other components within the network to perform their functions.

There is a wide range of energy storage technologies, including small- and large-format lithium iron phosphate (LiFePO₄) and lead-acid (Pb) batteries. ALL batteries are “consumable” parts of the HPS.

While the role ESMs serve can be widely varied, their function is quite simple: ESMs discharge and recharge over time; this is known as “cycling”. Batteries are designed with a finite cycle-life expectancy, and several factors will determine just how many cycles a battery can endure before it is depleted:

1. Cell chemistry
2. Operational environments and conditions
3. Charging and discharging rates
4. Storage conditions (even though it may not be actively cycling, the chemical reaction in a battery never stops.)

All of these play roles in cycle-life expectancy, so selecting the best battery for a particular application is critical.

Formats and chemistries are selected based on the requirements of a particular application, but regardless of the battery type used in an HPS, there are two common attributes of all ESMs:

- Scalable—ESMs are scalable to meet System performance requirements.
- Modular—ESMs can be rotated, serviced, and/or swapped within the Inter-Connect network.

When assembling ESMs into an HPS for a particular application, the following need to be considered:

- Consistency of chemistry
- Consistency of operating voltage
- Proper cycling (depth of discharge and peak of recharge, 1-2 cycles daily, charge/discharge rates)
- Proper capacity for the intended load / application
- “One” battery bank (connected together, not disparately)

Important Product Safety Information and Instructions

This manual contains important safety instructions that must be followed during the installation and operation of this product. Read all instructions and safety information contained in this manual.

While this product is designed for indoor/outdoor operation, the user interface (control panels) must not be exposed to rain, snow, moisture, or liquids. Close and latch and/or lock the cases when the equipment is unattended.

Exercise caution when handling or operating equipment. Live power may be present.

Safety Information Labels

Your safety and the safety of others is very important.

Always read and obey all safety messages.



This is the safety alert symbol. This symbol alerts you to potential hazards that can kill you or hurt you and others. All safety messages will follow the safety alert symbol and the word “DANGER”, “WARNING”, or “CAUTION”. These words are defined as:

⚠ DANGER Indicates a hazardous situation which, if not avoided, will result in death or serious injury.

⚠ WARNING Indicates a hazardous situation which, if not avoided, could result in death or serious injury.

⚠ CAUTION Indicates a hazardous situation which, if not avoided, could result in minor or moderate injury.

All safety messages will tell you what the potential hazard is, tell you how to reduce the chance of injury, and tell you what can happen if the instructions are not followed.

Limitations on Liability

Since the use of this manual and the conditions or methods of operation, use, and maintenance of this product are beyond the control of Solar Stik, this company does not assume responsibility and expressly disclaims liability for loss, damage, or expense—whether direct, indirect, consequential, or incidental—arising out of or anyway connected with such operation, use, or maintenance.

Due to continuous improvements and product updates, the images shown in this manual may not exactly match the unit purchased.

This equipment **CAN BE USED FOR CONNECTION WITH LIFE SUPPORT SYSTEMS OR OTHER MEDICAL EQUIPMENT** or devices; however, without limiting the generality of the foregoing, Solar Stik makes no representations or warranties regarding the use of the System in connection with life support systems or other medical equipment devices.

Fire Hazard

Fire Types

Class A fire - Fires in ordinary combustibles such as wood, paper, cloth, trash, and plastics.

Class B fire - Fires in flammable liquids such as gasoline, petroleum, oil, and paint.

Class C fire - Fires involving energized electrical equipment such as motors, transformers, and appliances. Remove the power source and the class C fire becomes a class A or B fire.

Recommended Fire Extinguisher

NSN 4210-00-288-7219 Fire Extinguisher, Carbon Dioxide, 10 lb

Carbon dioxide is a liquefied gas, which is highly effective fighting class B and C fires. These extinguishers are ideal for areas where contamination and/or cleanup are a concern, such as data processing centers, labs, and telecommunication rooms.

⚠ WARNING

Only CO₂ (carbon dioxide) fire extinguishers should be used with Solar Stik equipment.



Using the Fire Extinguisher

When using the extinguisher on a fire, remember PASS:

Pull the pin.

Aim the nozzle or hose at the base of the fire from a safe distance.

Squeeze the operating lever to discharge the fire extinguishing agent.

Sweep the nozzle or hose from side to side until the fire is out. Move forward or around the fire as the fire diminishes.

Watch the area for reignition until the cause has been fixed.

These additional cautionary steps will ensure your safety:

- System components should not be operated in standing water.
- System cables should not be routed through standing water.
- Cable connections should remain dry.
- Unused ports on System components should be covered when not in use to reduce the possibility of water intrusion.

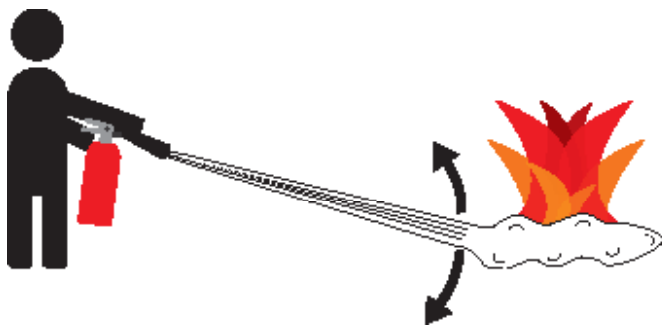

Use Sweeping Motion

Electric Shock Hazard

⚠ WARNING

Standing water around the electrical equipment and/or intrusion of water into the System components can increase the risk of electrical shock.

DON'T LET THIS BE YOU!



HIGH VOLTAGE: System components, photovoltaic (PV) arrays, and generators may produce lethal line voltages. Extreme care should be taken to protect against electrocution. Always work with another person in case an emergency occurs. Disconnect power before performing maintenance. Wear safety glasses whenever working on any part of a System that requires exposure to mechanical or direct electrical contacts.

⚠ WARNING

The Expander Pak is NOT GFCI protected.

Environmental and Handling Precautions

Water

The Expander Pak lid is fastened so that it may not be opened during normal use. The Expander Pak must be in an upright position with the lid is on top during outdoor storage and/or operation to prevent water intrusion.

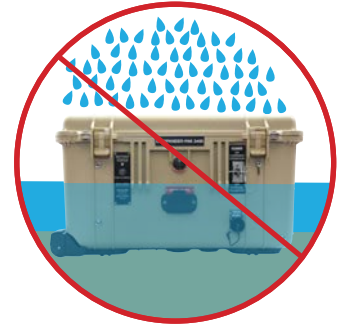

Impact

The Expander Pak should not be dropped onto hard surfaces at a height greater than one foot when transporting or during operation.



Dust

As a general rule, minimize exposure to high levels of particulates by exercising common-sense placement.



Heat

Heat and solar loading reduce efficiency and life expectancy. **Shade the Expander Pak to prevent the negative effects of heat.**



PRINCIPLES OF OPERATION – THE EXPANDER PAK

The Expander Pak is designed as a modular, scalable energy storage module (ESM) for service in any stand-alone power platform. Insertion of an Expander Pak into a circuit allows the operator to “expand” the architecture and improve the operating the efficiency of the entire network.

Expander Paks serve as the foundation for all hybrid power systems, and allow both renewables and traditional power sources to be used in concert.

The 24VDC Li Expander Pak 2400 offers the following:

- 100 Ah (2.4 kWh) of energy storage capacity
- LiFePO₄ chemistry
- High energy density – twice that of lead-acid (double the energy for its weight)
- High cycle life > 3000 cycles
- Plug & Play connections
- Rapid and deep discharges (can go to near 0% without hurting the cells)
- Rapid recharges
- Circuit protections
- Battery Status LED
- Two-person lift
- Inert and nonhazardous when 100% discharged
- Ruggedized for extreme conditions
- Designed to MIL-STD-810G; GVT Safety Confirmation for worldwide deployment
- DOT–approved for land, sea, and air cargo transport

Adherence to operation and safety protocols will yield optimal performance from the Li Expander Pak for many years. Procedures for operation, preventive care and maintenance, and troubleshooting are all in this manual. Please read thoroughly before operating the Li Expander Pak.

Advanced Battery Management System (BMS)

The 24VDC Li Expander Pak consists of LiFePO₄ cells and an advanced battery management system (BMS) that performs two vital functions:

- The BMS manages the battery functions and promotes healthy cycling at the cells.
- The Protection Circuits protect the cells (and the operator) from dangerous conditions related to cell voltages, temperatures, and current flowing in/out of the battery.

When all of the operating conditions are satisfactory, direct current (DC) can flow in/out of the battery cells (cycling). If the temperature, voltage, or current is outside of the preset limits, then the BMS Protection Circuits engage and remove the cells from service by disabling the battery at its terminals until proper operating conditions are restored.

The Inter-Connect System

The System is comprised of three (3) distinct types of technologies:

- Energy storage
- Power management
- Power generation

All of the individual components that operate in these categories utilize a unique connection architecture known as the Inter-Connect Circuit.

The Inter-Connect Circuit is the connection framework of the System's DC power network. It uses a simple, polarized, locking connection that is common throughout the architecture. All power management, energy storage, and power generation components are compatible with the Inter-Connect Circuit.

Using a common, polarized connector allows rapid "Plug & Play" scaling of components, adaptation of capabilities within the architecture, technology refreshment, and swapping of components when conditions warrant. It also ensures that there is no unsafe way to make connections.

Circuit Breaker Protections

The Inter-Connect network is protected from overloads and short circuits through a network of circuit breakers strategically placed throughout the circuit. It ensures the potential for a reverse polarity connection within the circuit is minimized. If a problem occurs in a leg of the Inter-Connect Circuit, the affected leg will disconnect from the primary network, leaving the other circuits functioning. If a major failure occurs in the circuit, then the entire network will shut down for System and Operator protection.

Operate with Voltage

The Inter-Connect Circuit communicates simple battery voltage to all components on the network, allowing them to independently coordinate their respective functions. Battery voltage is used to trigger actions such as Automatic Generator Start/Stop (AGS) function, power distribution timing, and more. Therefore, the proper setup of the Inter-Connect Circuit is critical to properly communicate voltage to all points in the System and to ensure all of the components operate together to provide seamless power to the load.

Optimize with Data

Data collection for a System occurs through the Inter-Connect network. Power management devices such as Power Hubs and PRO-Verters meter voltage, current and time through the circuit, providing critical real-time data the operator can use to troubleshoot and verify System performance. Data collection enables programming/architectural changes to optimize performance based on evolving conditions.

The Inter-Connect Plug

- Polarized
- 200 A maximum current
- 24 VDC connection only
- Mechanically “locks” into place
- Rotate knob clockwise to lock, counterclockwise to release
- Can be repaired or modified in the field



Figure 1. Inter-Connect plug

Optimizing the Battery Configuration

A hybrid power system will function most efficiently when proper balance is achieved within the System's architecture (Energy Storage, Power Management, and Power Generation). Generally, the amount of energy storage (battery capacity) required for any System will be directly proportional to the amount of load and power generation that is required for 1-2 battery cycles per day; however, two other factors may also play a role in determining the necessary capacity:

- Application (external factors such as logistics and operation climate)
- Capabilities (internal factors such as system composition, power generation, AC/DC power management, distribution, etc)

Power Management Components that are connected to the battery bank must be able to pull and push enough current (amps) to/from the batteries to support their individual functions. This requires the establishment of a "minimum" capacity for proper system operation.

For example, PRO-Verters can require extremely high current (amperage) from the batteries when AC loads require power from the inverter, but it can also push high current into the battery when it is in charge mode.

Each Expander Pak has a built-in circuit breaker/cap that will limit the amount of current that is available from the individual batteries. In most System configurations where Expander Paks are used, the combined values of the Expander Pak circuit breakers must be greater than the rated demand of the connected power management/distribution equipment.

Connecting an insufficient number of Expander Paks (energy storage modules) will result in a situation where the following may occur:

- Circuit protections may unnecessarily engage
- Inaccurate voltage readings falsely trigger voltage-related functions in the system
- Battery state of health and overall life expectancy is degraded due to excessive cycling

Refer to the "Minimum Battery Capacity Recommendations" In the System manuals or on relevant I-Plates to ensure trouble-free operation.

Determining Proper Battery Capacity for a System

Inherent to the HPS architecture is the ability to "scale" components to meet the System requirements, and a properly scaled battery bank is essential for successful operation of any HPS.

- **Power generated for a system must be equal to or greater than the total load requirement, so the battery bank must be able to store the requisite power.**

The "total load" in a 24-hour period can be used to baseline the energy storage capacity for a System. For example, if the total load requirement over 24 hours is 10 kWh, then the energy storage capacity can usually be scaled to that same metric. It is possible to use a smaller battery bank, but the following metrics must still be considered:

1. A "cycle" should not occur in a period of less than 12 hours (1-2 times daily).
2. The limits of the Expander Pak circuit protections must be able to meet the demands of discharge and recharge current.

Scaling Methods

“Plug & Play” architecture allows rapid expansion or contraction of battery capacity when conditions warrant.

Use Inter-Connect Strips and Inter-Connect Cables to create an “bank” of Li Expander Paks (Figure 2).

If a Solar Stik System needs to be downsized, due to either reductions in the load or simply to reallocate energy storage resources to other locations, then Li Expander Paks can be removed from service in accordance with reductions in runtime requirements.

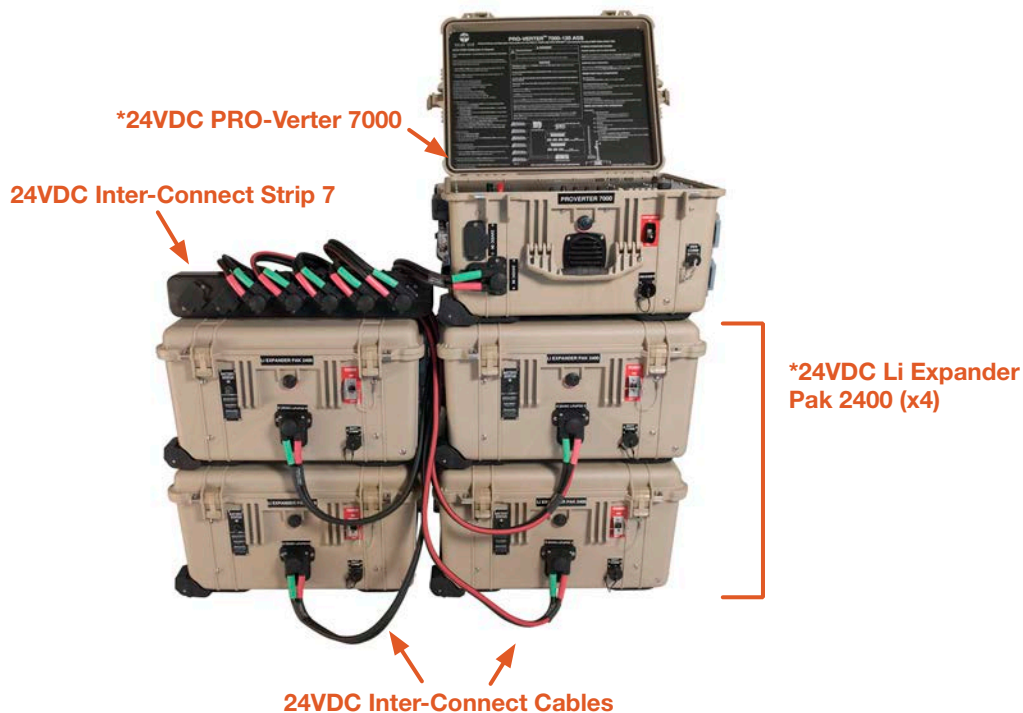

Figure 2. Connecting Li Expander Paks using Inter-Connect Strips and Inter-Connect Cables

*Solar Stik power management components have minimum battery capacity requirements for operation at their rated capacities. Consult the individual component manuals for their minimum capacity requirements.

Keys to Expander Pak Performance

- All Expander Paks should be connected into “one” common bank.
- All Expander Paks comprising a battery bank should be the same chemistry.
- All Expander Paks operating in a bank should be close in health (age, cycles, capacity).
- Follow initialization and calibration steps in System manuals when putting Expander Paks into service in a bank (system).
- Expander Paks prefer to be charged using a PRO-Verter or Power Hub. If any other charging device is used, it must be rated for the Expander Pak’s storage capacity, voltage, and current limit (see [Alternative Charging Methods](#)).
- Accurate monitoring (current, voltage, SOC, cycles, etc.) of a bank of Expander Paks should be obtained from the system’s PRO-Verter or Power Hub. **Note:** Information about an individual Expander Pak is not reported by the PRO-Verter or Power Hub.
- Fully charge Expander Paks before placing them into storage.

Equipment Description

- A. Battery Status LED:** Displays battery operation status.
- B. Power Switch:** Enables Operation or Storage Modes.
- C. Inter-Connect Port:** Port for connecting the Li Expander Pak to the Inter-Connect Network.
- D. Tech Port:** Provides access to current and historical data from the Li Expander Pak BMS. A BMS reader (sold separately) is required to access information from this port.

	Description	Connector	Voltage	Amps	Watts
A	Battery Status LED and momentary switch				
B	50 A circuit protection breakered switch			50 A	1200 W
C	24 VDC LiFePO ₄ Port	Inter-Connect Port	24 VDC	50 A	1200 W
D	Tech Port	Ethernet - RJF21B	-	-	-

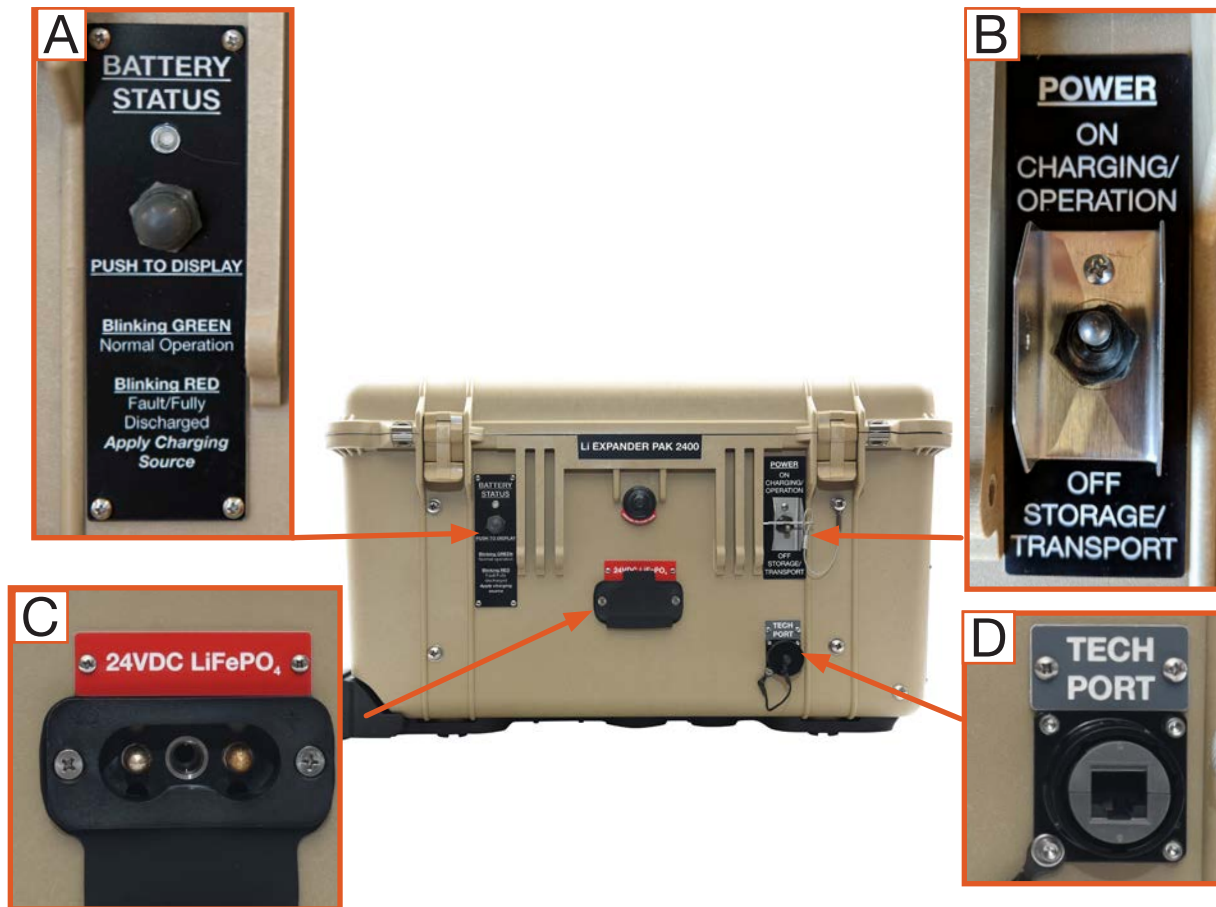

Figure 3. Placards on the front of the 24VDC Li Expander Pak 2400

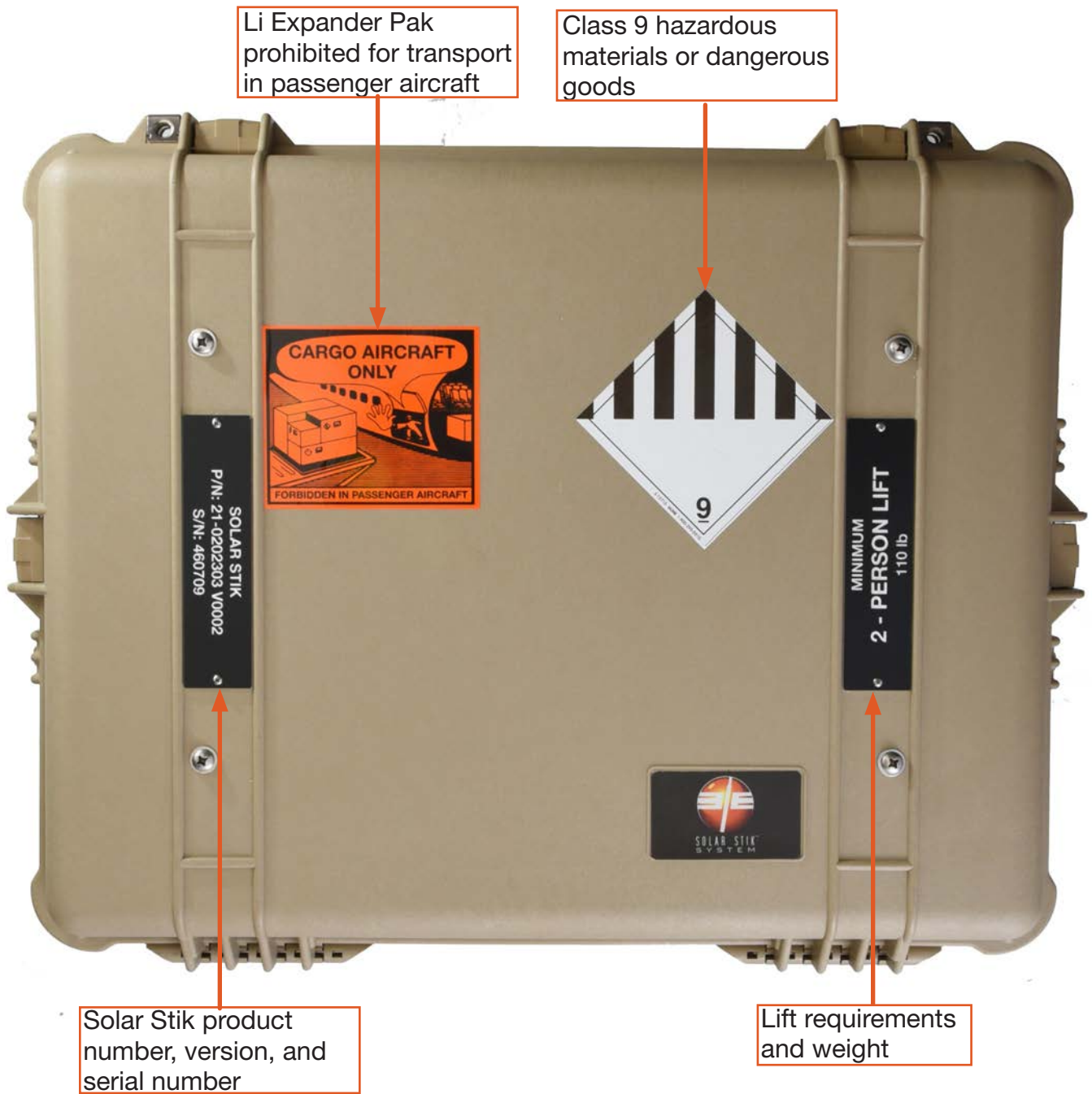

Figure 4. Labels on the top exterior of the 24VDC Li Expander Pak 2400

Data Plate (D-Plate)



Figure 5. 24VDC Li Expander Pak 2400 D-Plate

24VDC Li EXPANDER PAK 2400

Recommended Safety Equipment

10 lb carbon dioxide fire extinguisher
NSN 4210-00-288-7219

Battery Specifications

Chemistry: Lithium Iron Phosphate (LiFePO₄)
Capacity: 100 Ah (2.4 kWh)
Operating voltage: 24.0 VDC to 28.8 VDC
Maximum charge/discharge current: 50 A
Over voltage limit: 29.2 VDC
Under voltage limit: 21.6 VDC

Charging

- 1) Use a Solar Stik PRO-Verter that is configured for LiFePO₄ batteries.
- or
- 2) A charger that is configured for LiFePO₄ batteries that **DOES NOT EXCEED 50 A.**

Environmental

Operating temp: -13 °F to 149 °F (-25 °C to 65 °C)
Charge temp: 41 °F to 113 °F (5 °C to 45 °C)
Storage temp: -22 °F to 158 °F (-30 °C to 70 °C)

Storage

Charge the Li EXPANDER PAK completely before storage and recharge fully every three months

Transport

Class 9 hazardous material transportation restrictions.
UN3481 Lithium Ion batteries contained in equipment
See manual for SDS.

Technical Support

1-800-793-4364 Ext 102
tech@solarstik.com

Made in USA

OPERATOR INSTRUCTIONS

The 24VDC Expander Pak 2400 normal operating voltage ranges from 21.0 VDC to 29.0 VDC. Prior to operating the Expander Pak for the first time, charge it fully. Recharge it with connection to a PRO-Verter, Power Hub, or an external charging source, such as a battery charger, until the battery reaches 100%SOC.

Connect the Inter-Connect Cable to the Expander Pak

1. Connect the straight plug to the Expander Pak. The plug and socket are polarized (Figure 12A) and can be connected only in the proper orientation.
2. After inserting the plug into the socket (Figure 12B), twist the knob to lock the connection.

Note: The red wire cover denotes the positive (+) terminal, and green denotes the negative (-) terminal.

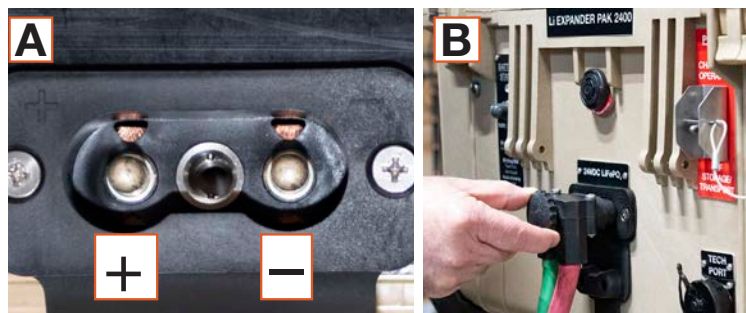

Figure 6. Connecting Inter-Connect Cable to Expander Pak

Connect Expander Paks to Inter-Connect Strip

Connect multiple Expander Paks be in parallel using an Inter-Connect Strip 7 (Figure 7).

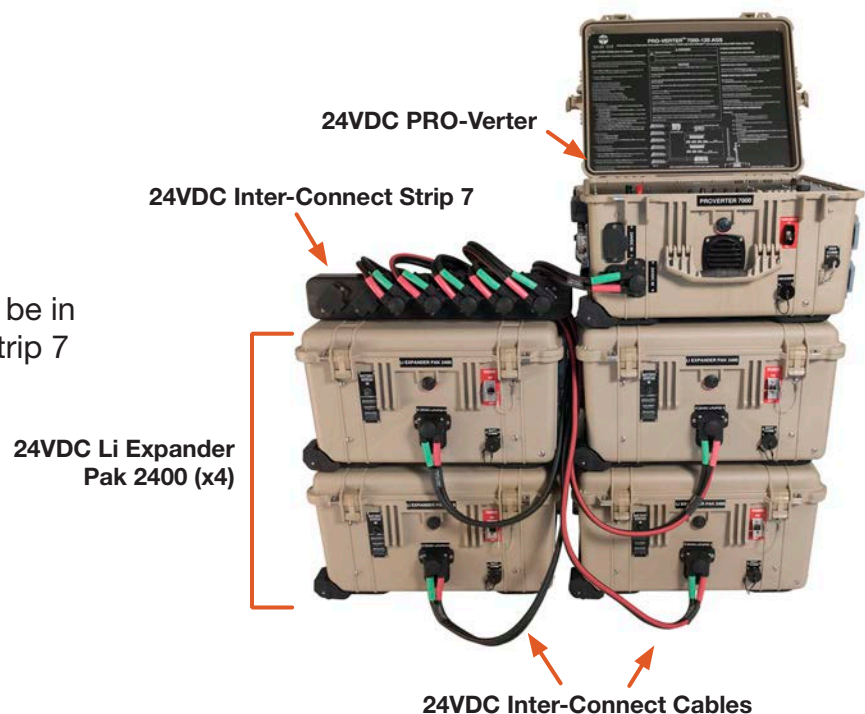

Figure 7. Connecting and stacking multiple Expander Paks

Connect Expander Paks to Power Management

Expander Pak-specific ports on Solar Stik power management components are labeled. Individual Expander Paks or a bank of Expander Paks can be connected to these ports. Expander Pak-specific ports are metered and can be used to measure the amount of energy flowing into and out of the bank of Expander Paks.



Figure 10. Connecting Expander Paks to Solar Stik power management

Activate Expander Pak and Check Battery Status

1. Remove the pin from the switch protector and move the power switch to the “ON CHARGING/OPERATION” position (Figure 8).
2. Check the battery status. The Li Expander Pak Battery Status LED is activated by depressing the momentary switch (Figure 9). The LED will either flash (green or red) or emit no light (see Table 1)



Figure 8. Li Expander Pak power switch

Table 1. Battery Status LED Color and Corresponding Condition

Color	Frequency	Condition
Green	Flashing	Normal operation
Red	Flashing	Protection circuits engaged: 1. Cell overvoltage 2. Cell undervoltage 3. Overcurrent (charge or discharge) 4. Overtemperature (> 160 °F/71 °C) 5. An internal battery fault (such as a broken wire, etc.)
None	N/A	Expander Pak power switched off, battery inoperative

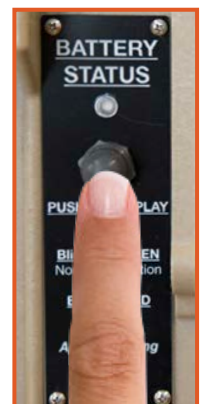

Figure 9. Li Expander Pak battery status indicator

Monitoring Battery Status

Figure 11 describes how the changes in Battery Status LED color (red and green lines) relate to battery or cell voltage during charging and discharging (black arrows).

Note: The Battery Status LED does not report the state of charge (SOC).

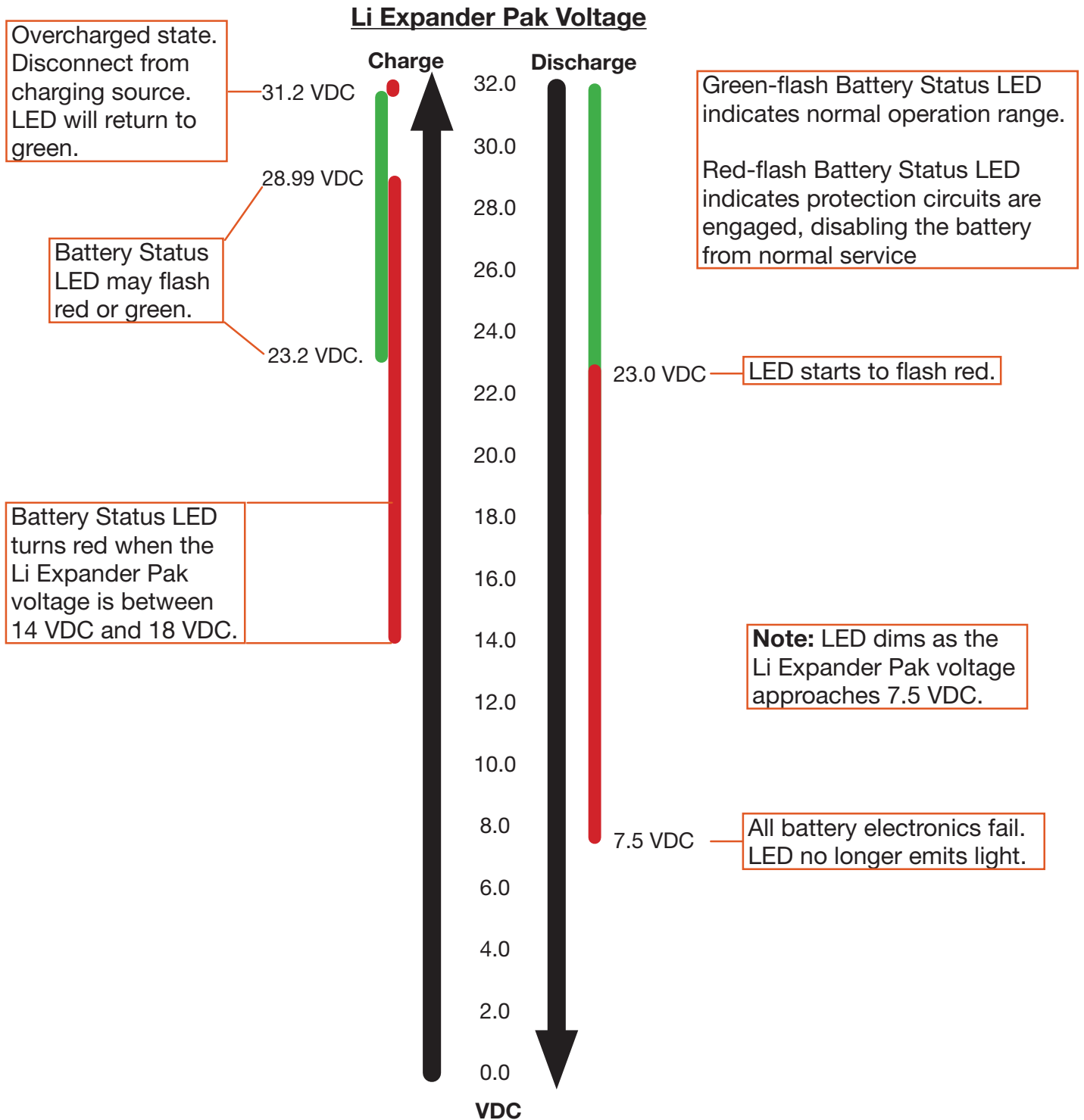

Figure 11. Battery Status LED color and Li Expander Pak voltage relationship

Alternative Methods of Recharging the Expander Pak

Alternative methods of recharging should be performed using only regulated charging sources appropriate for 24 VDC LiFePO₄ batteries such as the 24VDC Li Battery Maintainer shown in Figure 12.



Figure 12. 24VDC Li Battery Maintainer with Inter-Connect Plug

Recharging Voltage

Do not connect an external charging source that exceeds 29.8 volts to the post terminals. This may damage the battery and is not covered under any warranty.

Correct Polarity

Always connect to DC terminals using correct polarity. Failure to connect using correct polarity will trip the master breaker or trigger protection circuits to engage.

MAINTENANCE INSTRUCTIONS

Expander Pak Storage

There is a simple rule to remember about maintaining the Expander batteries:

Never store an Expander Pak in a discharged state! Charge the Expander Pak fully before placing it in storage.

Other than keeping the battery fully charged during storage, an LiFePO_4 -type of battery does not require any type of maintenance by the operator.

The Expander Pak has a relatively low self-discharge rate at 77 °F (25 °C) and can be stored for up to one (1) year at this temperature before it needs to be recharged. However, the self-discharge rate increases as the storage temperature increases. See In-storage Preventive Maintenance Checks and Services for complete specific charging instructions for a particular Expander Pak battery chemistry.

Note: If the Expander Pak is stored at temperatures above 91 °F (33 °C), then the time between maintenance checks and / or charges must be reduced to three (3) months.

In-Storage Charging Procedures:

Charge one—charge all. It is important to maintain an equal level of health between all Expander Paks in a System. If one (1) Expander Pak in a System needs to be charged during storage, it is likely that any/all others will also need to be charged. Charging all of the Expander Paks until they meet the criteria of being charged fully will maintain balance and equality among them.

CAUTION

Do NOT leave Li Expander Paks on a constant charge during long periods of storage. Cell damage may occur. Once the battery reaches 100% SOC during maintenance charging, the charging source should be removed until the next charging interval is determined.

Do NOT use a BMS reader to determine Li Expander Pak SOC during periods of storage. The BMS' reported values for SOC are not calculated using "cell self-discharge" information, which occurs in all batteries. The SOC may be reported at 100% even though the cells may only be at 50%.

In-storage Preventive Maintenance Checks and Services

Failure to follow these instructions may result in permanent equipment failure and/or personal injury.

Required Tools

Solar Stik PRO-Verter or LiFePO₄ battery maintenance charger.

Table 2. In-storage Preventive Maintenance Checks and Services

Item #	Item to be Inspected	Interval* at 91-140 °F (33-60 °C) Storage Temp	Interval* at 77-90 °F (≤ 25-32 °C) Storage Temp	Procedures	Non-mission Capable
1	Visual inspection of 24VDC Li Expander Pak 2400	M ¹	Q ²	<ol style="list-style-type: none"> Inspect case for visible damage and missing items. Clean excessive dust or dirt accumulation from the exterior and ports. Close all unused port covers. 	~If the case is broken or split or if ports are damaged, contact Solar Stik Technical Support for advice on how to proceed.
2	Battery Status LED color	M	Q	<ol style="list-style-type: none"> Push and hold the Battery Status LED button. Record the color of the Battery Status LED in the maintenance/service log If the Battery Status LED is flashing red on any Li Expander Pak, proceed to Item #3. 	~If the Battery Status LED emits no light, contact Solar Stik Technical Support or FSR.
3	In-storage maintenance charging	Q	S ³	<ol style="list-style-type: none"> Charge Li Expander Paks for 24 hours at 29.0 V. Follow the instructions for the lithium battery charger used. Charge until the Battery Status LED on all Li Expander Paks is flashing green (if flashing red to begin with). If the Battery Status LED flashes red on any Li Expander Pak after 24 hours, continue charging all Li Expander Paks for another 24 hours. 	~If any Li Expander Pak has a red-flash Battery Status LED after 48 hours of charging OR if the LED emits no light after charging, contact Solar Stik Technical Support.

¹Monthly (M)—every month ²Quarterly (Q)—every three months ³Semiannually (S) – every 6 months

TROUBLESHOOTING PROCEDURES

Required Tools

- Multimeter
- LiFePO₄ battery maintenance charger or a Solar Stik PRO-Verter

Resolving Red-flash Battery Status LED Conditions

Background

It is most important to maintain Li Expander Paks in such a way that they will never end up in a red-flash state. The Battery Status LED will flash red if any of the protection circuits engage.

Table 1 lists the most [common conditions that cause a red-flash Battery Status LED report](#) from an Li Expander Pak.

Note: The MKM BMS Reader is a tool (sold separately) that facilitates diagnosis and resolution of red-light Battery Status LED conditions. Use this tool if it is available. If one is not available and it is needed, contact Solar Stik for more information.

Instructions

1. Remove the Expander Pak from service.
2. Follow the instructions in the [Procedure for Recovering Li Expander Pak from Red-flash Condition](#).

Procedure for Recovering Li Expander Pak from Red-flash Condition

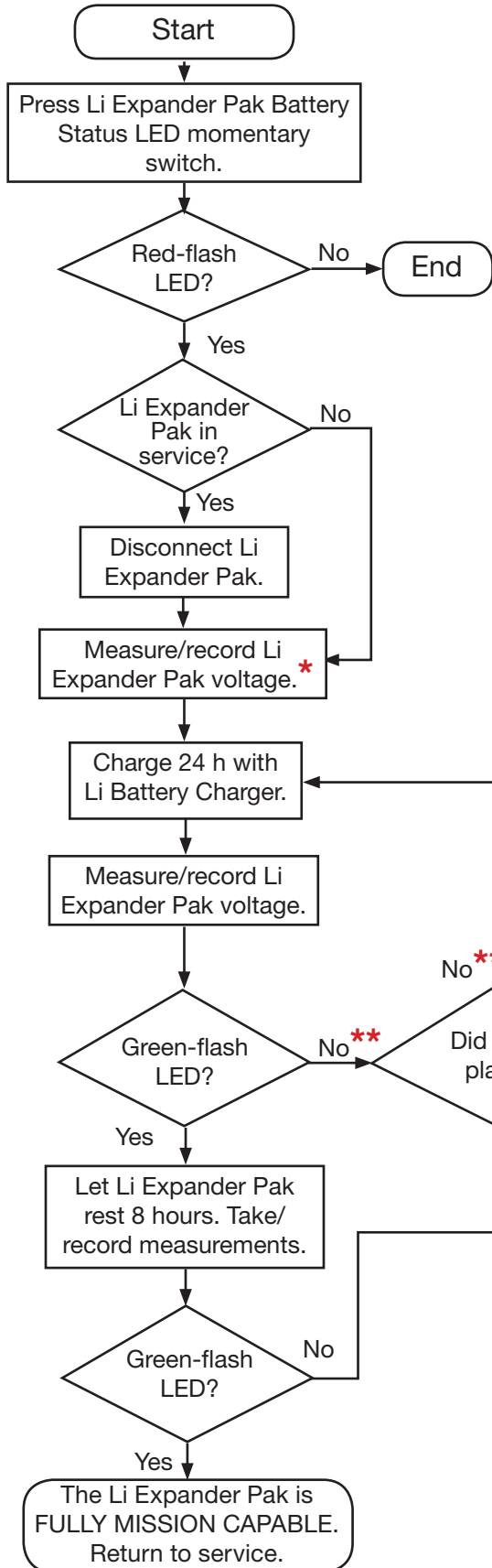

Legend

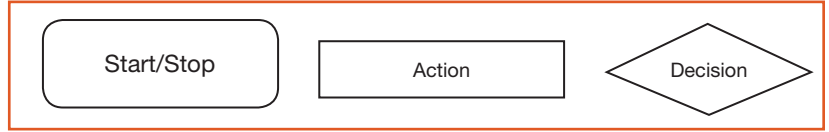

States That Define NMC/Bricked Status

a. Any maintained voltage less than 20 V **after** the charger has been disconnected for 8 hours indicates MULTIPLE failed cells in the Li Expander Pak. In this case, the Li Expander Pak is non-mission capable (NMC), or “bricked” and is **not** likely to be eligible for warranty replacement. The Battery Status LED will flash red. Contact Solar Stik Technical Support.

b. If the voltage of the Li Expander Pak can be maintained at 19–23 V **after** the charger has been disconnected for 8 hours, it is possible/likely there is a single (1) failed cell in the Li Expander Pak. In this case, the Li Expander Pak is NMC/bricked and **may** be eligible for warranty replacement. The Battery Status LED will flash red. Contact Solar Stik Technical Support.

Notes

* If the Li Expander Pak voltage measures above 31.2, it is overcharged. Removing it from its charging source should resolve this temporary red-flash Battery Status LED condition.

** If, after 48 hours of charging, the Li Expander Pak voltage remains below 26.5 and the Battery Status LED remains flashing red, the Li Expander Pak is NMC.

Resolving No-light LED Conditions

Background

If the Battery Status LED does not emit light when the button is pressed, the 24VDC Li Expander Pak 2400 has most likely been severely damaged. The types of potential damage include the following:

- **Intrusion of water or particulates** could cause transient or permanent failure of internal components, including the LED or its electrical connection to the battery.
- **Severe mechanical or physical shock** (sudden acceleration caused by impact, drop, earthquake, or explosion) could cause damage that results in the failure of the LED, or other internal components that result in no light being emitted from the LED.
- **Severe overdischarge.** The Battery Status LED stops emitting light when the Li Expander Pak voltage drops below 7.5 VDC. The LED may dim significantly as the voltage approaches this cutoff value. **Care must be taken to ensure that this situation does not occur because it may result in permanent failure of the Li Expander Pak.**
- **Failed LED.** The LED might prematurely reach the end of its lifespan and require replacement.

Instructions

1. Remove the Expander Pak from service.
2. Turn on the Li Expander Pak power switch and measure the voltage across the Inter-Connect port terminals.

A reading of 20.0 volts (the “terminal disconnect voltage”) or less indicates that the battery BMS has disconnected internal cells from service. Voltages measured may be variable and are not necessarily an indication that the BMS has reconnected the internal cells to service.

3. Turn off the Li Expander Pak power switch for safety.
4. Remove the four (4) fasteners (Figure 15) from the top of the Li Expander Pak and unlatch the four (4) latches.



Figure 13. No-light LED condition

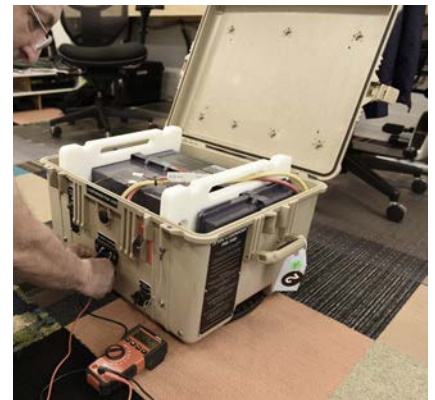

Figure 14. Measuring voltage across terminals of Inter-Connect port



Figure 15. Screw locations on top of Li Expander Pak

5. With the power switch in the OFF position, open the lid, and immediately visually inspect the interior of the case for damage or water or particulate intrusion. Refer to [Water Intrusion Remediation](#) section for instructions regarding water intrusion. Turn on the main power switch only after the interior of the Li Expander Pak is completely dry. Then proceed with step 6.

6. Visually confirm that the BMS LED indicator light (Figure 16) is working. It should be flashing green if the battery is charged—or if the Li Expander Pak is above 23.0 volts. If the BMS LED is flashing, the issue with the battery status indicator LED on the front of the Li Expander Pak is “downstream” from that point. **Note:** Make this observation in a low-light environment because the BMS LED may become very dim.



Figure 16. BMS LED indicator light

7. Inspect the white plastic Molex connector for damage (Figure 17). Tug gently on the three (3) wires inserted into both ends of the connector to determine if there is a bad crimp or improperly seated pin. Reconnect any wires that are not properly connected. If the wires are properly connected, move on to step 8.

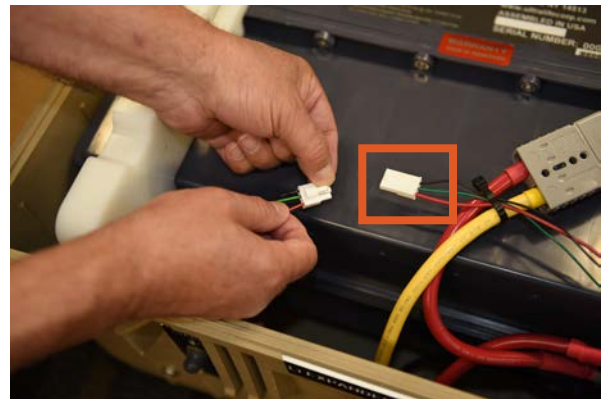

Figure 17. Inspecting Molex connector

8. Measure the voltage across each of the wires.

Insert the leads of a multimeter into the holes (arrows in Figure 18) of the battery side of the Molex connector. Measure red to black and green to black. These should produce voltages of ≤ 2.0 mV. If these voltages are present at these points, move to step 9. If no voltage can be detected, there is a problem with the internal circuitry of the battery. Contact Solar Stik Technical Support.

Note: The larger gauge of some lead probes can make it difficult to make electrical contact inside of the connector. If a zero (0) reading is observed, ensure that it is not due to failure to make electrical contact.

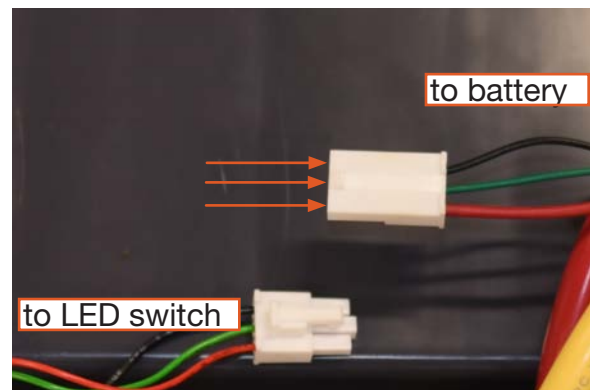

Figure 18. Measuring voltage across wires

9. Check the momentary switch for loose connections and perform a continuity test.

Check the momentary switch fasteners (Figure 19). If they are loose, tighten them.

Set the meter for continuity. The reading should be ~0.00 when the button for the battery status LED is depressed (there may be an audible signal if the meter is equipped with one) and 0.L (overload) when the button is released.

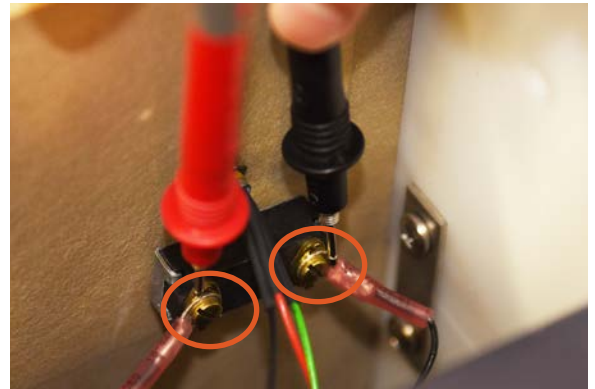

Figure 19. Momentary switch fasteners

10. If the Battery Status LED on the case exterior is properly connected and not damaged, the most likely cause is that the Li Expander Pak has been severely overdischarged (7.5 VDC or less) at which point, the Li Expander Pak is NMC.

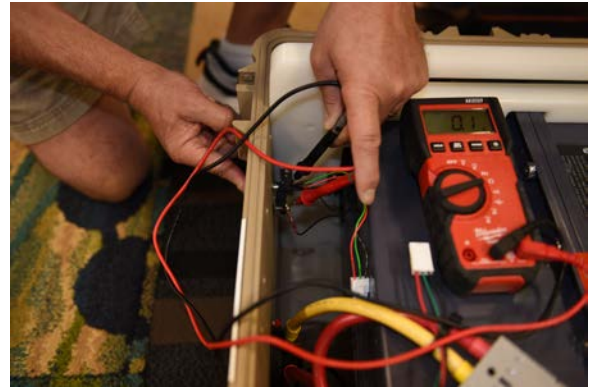

Figure 20. Performing continuity test

Summary

One of the tests or observations described above should provide the answer to the specific reason for the no-light LED situation. If a battery is properly maintained and has not experienced abuse, it is unlikely that this situation will be encountered.

Temporary LED failure due to moisture intrusion has been observed. Ensure that the interior and all components are dry if the cause of the no-light condition is not resolved by any of the steps above.

MAINTENANCE INSTRUCTIONS

Preventive Care and Maintenance

Note: The function and efficiency of all electronic equipment is related to and dependent upon the temperature at which it is operating. It performs optimally within a narrow temperature range and less so as the temperature falls outside of that range. Heat will cause the Li Expander Pak to derate. Please use the following measures to mitigate against heat and other environmental effects:

- The Expander Pak should be shaded from direct sun exposure and sheltered from the elements as much as possible during operation.
- Keep the case lid and Inter-Connect covers closed to prevent water and dust intrusion.
- Check the integrity of electrical connectors on a monthly basis.

Water Intrusion—Prevention and Remediation

⚠ WARNING

Standing water around the electrical equipment or intrusion of water into the System components can increase the risk of electrical shock.

- If water intrusion is suspected, do not try to move what may be a flooded component while it is still powered up. The sensitive electronics are mounted just a short distance from the bottom of the case. If water has intruded and splashes around inside the case during transport, damage to the sensitive electronics may occur.
- Remove the screw from the drain hole at the bottom edge of the component case. If water flows out of the drain hole after removal of the plug, let it flow until it stops. Then slightly and slowly tilt the case toward the drain hole to remove any remaining water. Continue to increase the angle of the component slowly until no more water drains from the hole. After the water has been drained, move the component to a safe dry location. Open the lid of the Expander Pak by removing the four (4) fasteners on the top (Figure 22 A) and undoing the case latches (Figure 22 B). Place the component in the most dry environment possible for a time long enough that any remaining moisture inside will dry. When it is dry, refasten the lid and reintegrate the component to the System. Test it to determine if it is still functional.



Figure 21. Li Expander Pak drain plug location

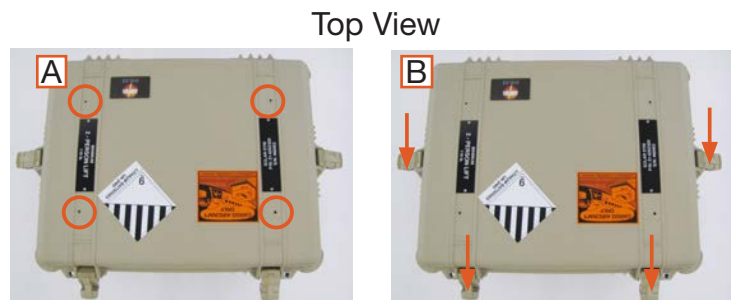

Figure 22. Opening the Expander Pak Case Lid

Service Parts

Battery Service Kit

(1) 21-0001006, Service Kit includes:

- (1) 02-1000057, MKM Replacement Battery (Figure 23)
- (1) 07-1000891, 8" Cable Tie
- (1) 07-1000895, 4" Cable Tie
- (1) 07-1000651, 10-32 x 1 1/2" Pan Head Machine Screw
- (1) 07-1000592, 10-32 Nylock Nut

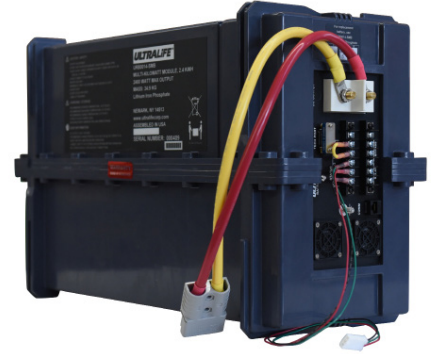

Figure 23. MKM URB0014 Battery

MKM Replacement/Maintenance Record

Date of MKM Replacement _____

Serial Number of MKM removed _____

Serial Number of MKM installed _____

SUPPORTING INFORMATION

24VDC Li Expander Pak 2400 Upgrade Product Change Notice

PCN1701002

Effective Date: May 26, 2017

Change Class: Major.

Reason for change:

The 24VDC Li Expander Pak 2400 V0002 Upgrade focuses on reducing the quiescent load of the cooling fans inside the battery. In addition, the Li Expander Pak status LED no longer shows orange/amber. Specifically:

1. The temperature at which the cooling fans engage and disengage has been raised from 95 °F (35 °C) to 115 °F (46 °C). The 35 °C setting was a conservative value. 46 °C is optimal for the modest discharge rates typical in Solar Stik applications.
2. The cooling fans will not run if the current in or out of the Li Expander Pak is less than 1 A, regardless of temperature. The logic is that at low currents the battery temperature is not a function of charging or discharging, but of the ambient temperature, so running the fans in this situation has no benefit.
3. A second pole has been added to the Power On/Off Switch to enable a deeper sleep state for storage and transportation. With this change the cooling fans will not run and the LED status light is disabled when the switch is in the off position, regardless of temperature.
4. Whereas originally the Battery Status LED flashed orange/amber when the battery no longer accepted charge (such as when it was full), now it will just continue to flash green. This eliminates the confusion over the amber light.

Collectively, these improvements reduce the self-discharge rate while in operation and dramatically improve the length of time before recharging is required during storage and transportation.

Item(s) Affected

Item #	Item Description	Summary of Change
21-0202303, Rev –	24VDC Li Expander Pak 2400	Changes to reduce quiescent load of Li Expander Pak

This change increments the revision number of 21-0202303 from Rev – to Rev A.

Rev. A units, including factory-upgraded units, can be identified by a “V0002” designation next to the item part number. See Figure 24.

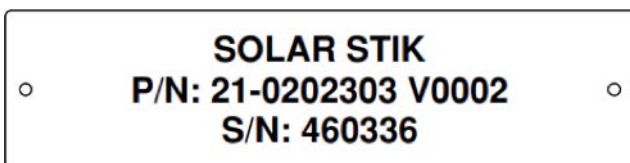

Figure 24. Example V0002 designation

Field-upgraded units can be identified by a “VF002” designation next to the power switch. See Figure 25.

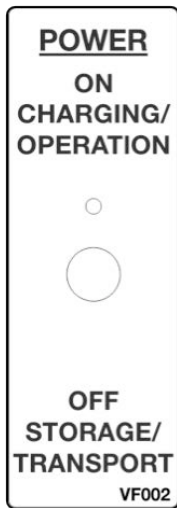

Figure 25. Example VF002 designation

Note: Effective September 21, 2017, Solar Stik changed its assembled product revision standard. Solar Stik’s Product Revision numbering system is now derived from ASME Y14.35 and EIA-649-B standards. Prior to this date, the first revision of a product (i.e. the second version) was designated Vx002. As of this date, the first revision is now designated Rev A. Therefore V0002, VF002 and Rev A all reflect the same revision number.

First serial number affected: 460668

Affected documents: For Rev A of the Li Expander Pak, Technical Bulletin 1A, and the Li Expander Pak–specific guidance in the AES Deployment Guide (all versions) is replaced by Operator and Maintenance Manual for 24VDC Li Expander Pak 2400 (Version 1.0).

Availability

Rev A is currently in production. Units returned to Solar Stik for servicing will typically be upgraded to Rev A.

A field upgrade kit is available, P/N 21-0202313, 24VDC Li Expander Pak 2400 Field Upgrade Kit VF002. In addition to the Upgrade Kit, a firmware programmer (a dongle that installs the firmware) must be obtained from Solar Stik to complete the upgrade.

Contact Information

Solar Stik, Inc.
226 W King St
Saint Augustine, FL 32084
1.800.793.4364

Point of Contact: Glen Flitter
Email: gflitter@solarstik.com
Phone: 1.800.793.4364

V0001 and V0002 24VDC Li Expander Pak 2400s

The upgrade of the 24VDC Li Expander Pak 2400 from V0001 to V0002 involved changes to internal controls designed to slow the rate of discharge due to quiescent loads during storage and transport (i.e., not in service) as well as eliminate the AMBER report from the Battery Status LED. The upgrade to V0002 consists of a change in the battery management firmware and new placards to reflect the changes provided by the new firmware.

The amber-colored Battery Status LED was eliminated to simplify and clarify reporting of the status of the battery and to provide clear instructions for what to do when a red-flash status situation occurs. The change in the way the Battery Status LED reports the state of the battery does not reflect any physical changes in the battery.



Figure 26. V0001 and V0002 Battery Status LED placards

The main breaker or power switch for V0002 has added functionality. Turning the switch off places the Li Expander Pak into a “sleep mode” to reduce significantly the quiescent load on the battery, thereby slowing battery discharge during storage or transport. The placard has been updated to reflect this change and to clarify that the switch must be in the ON position for it to be charged.

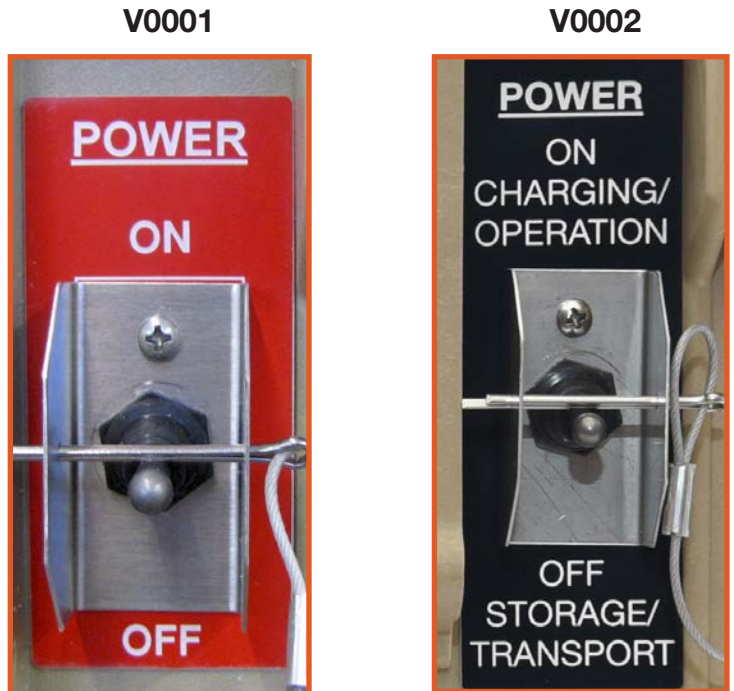

Figure 27. V0001 and V0002 power switch placards

The Solar Stik part number (P/N) and serial number (S/N) placard on the top of the Li Expander Pak is updated to reflect the upgrade.



Figure 28. V0001 and V0002 product and serial number placards

MKM BMS Firmware Update

Determine the Firmware Version

Open the 24VDC Li Expander Pak 2400 case to access the inside and remove the MKM battery (URB0014-SMB). Please refer to the Li 2400 Battery Service Kit Instructions for further information.

If the label indicates that the firmware is version 8.6, it has already been updated. Replace the MKM.

If the MKM firmware version is 8.4 (recorded on the label to the right of the tech port; see Figure 29), the BMS Programming Software must be updated.



Figure 29. Removing Tech Port cover

Update the BMS Programming Software

1. Use a #1 cross tip screwdriver to remove the Tech Port cover.
2. Connect the URB0014 Firmware Loader version 8.6 (Figure 30) to the Tech Port (Figure 31). The indicator light on the Loader will flash green once to indicate positive connection.

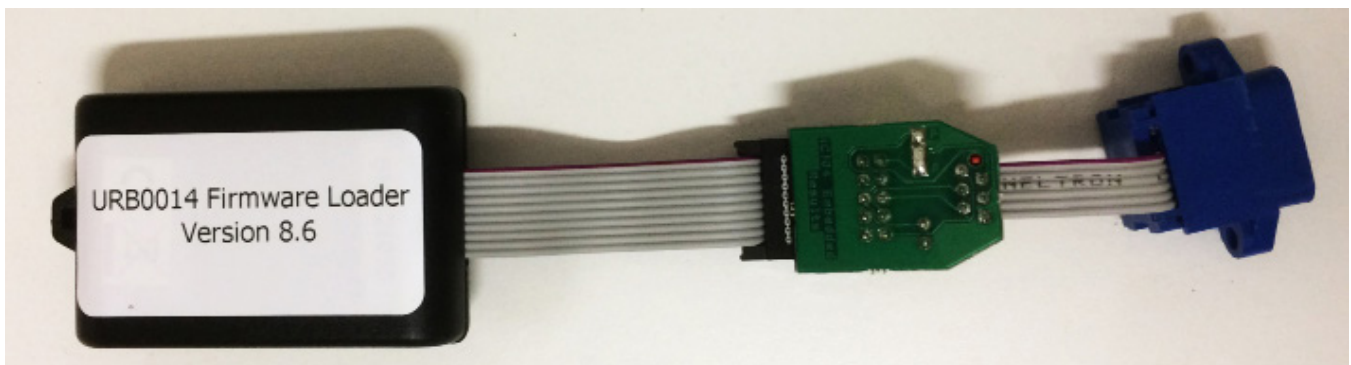

Figure 30. MKM BMS Firmware Loader



Firmware version 8.6
(after update)

Figure 31. Firmware Loader connected to the MKM Tech Port

3. Press the red button on the Loader and hold. The indicator light will be a solid green. Hold the button until the indicator light starts flashing at a slower rate. Release the button. As the firmware update gets loaded into the MKM, the indicator light on the Loader will flash at various rates. When the fans come on, the indicator light on the Loader goes out. The status light on the MKM comes on solid green, flashes off, then solid red, flashes off, then a solid amber, and flashes off. Finally the MKM status light flashes green at a constant rate, indicating the completion of the firmware update process.
4. Remove the Loader from the Tech Port connection and replace the Tech Port cover.
5. Use a permanent marker to write “8.6” over the 8.4 version number.
6. Reassemble the Li Expander Pak per the Li 2400 Battery Service Kit Instructions.
7. Use a permanent marker to write “8.6” underneath the red power switch placard.

Note: The main breaker/power switch must be updated for the Li Expander Pak to take full advantage of the updated firmware.

Li Expander Pak Transport

Air

The following information is a summary of the conditions that apply to the 24VDC Li Expander Pak 2400 for air transport:

- **Dangerous Goods Training.** The international and U.S. transportation regulations require personnel involved in shipping the 24VDC Li Expander Pak 2400 to complete the appropriate level of HAZMAT training.
- **Classification.** The 24VDC Li Expander Pak 2400 is classified as Class 9 hazardous material.
- **Testing.** The LiFePO_4 cells of the UltraLife URB0014-SMB MKM and the battery itself have passed UN T1 – T8 tests.
- **Short Circuit Protection.** The UltraLife URB0014-SMB MKM contained in the 24VDC Li Expander Pak 2400 is protected against short circuit and unintended movement.
- **Accidental Activation.** The 24VDC Li Expander Pak 2400 is protected against accidental activation.
- **Net Weight Limit.** The net weight of the lithium batteries in the 24VDC Li Expander Pak 2400 is 34.6 kg and is below the maximum of 35 kg net weight limit.
- **Marking and Labeling.** The 24VDC Li Expander Pak 2400 must bear the following labels: Class 9 hazard and Cargo Aircraft Only labels. Packages must also be marked with Proper Shipping Name (UN3481 Lithium Ion Batteries Contained in Equipment) and Shipper and Consignee addresses.
- **Shipper's Declaration for Dangerous Goods.** A Shipper's Declaration for Dangerous Goods must be filled out and accompany the 24VDC Li Expander Pak 2400 for air transport. The certifying official must have the requisite training.
- **Master Air Waybill.** The Master Air Waybill or Bill of Lading (BOL) is the document that describes the shipment.

Ground

The following information is a summary of the conditions that apply to the 24VDC Li Expander Pak 2400 for ground transport:

- **Dangerous Goods Training.** The international and U.S. transportation regulations require personnel involved in shipping the 24VDC Li Expander Pak to complete the appropriate level of HAZMAT training.
- **Classification.** The 24VDC Li Expander Pak 2400 is classified as Class 9 hazardous material.
- **Testing.** The LiFePO_4 cells of the UltraLife URB0014-SMB MKM and the battery itself have passed UN T1 – T8 tests.
- **Short Circuit Protection.** The UltraLife URB0014-SMB MKM contained in the 24VDC Li Expander Pak 2400 is protected against short circuit and unintended movement.
- **Accidental Activation.** The 24VDC Li Expander Pak 2400 is protected against accidental activation.
- **Net Weight Limit.** The 34.6 kg net weight of lithium batteries in the 24VDC Li Expander Pak 2400 meets the maximum of 35 kg net weight limit.
- **Marking and Labeling.** The 24VDC Li Expander Pak 2400 must bear the following labels: Class 9 Hazard label, "Cargo Aircraft Only" label. Packages must also be marked with Proper Shipping Name (UN3481 Lithium Ion Batteries Contained in Equipment) and Shipper and Consignee addresses.
- **Shipper's Declaration for Dangerous Goods.** Not required, but may be requested by your shipper.

Disposal – LiFePO₄ Battery

As a general rule, lithium-ion batteries are managed as universal waste under the Resource Conservation and Recovery Act. However, battery disposal regulations vary on national, state/provincial, and installation levels. Disposal must be conducted in accordance with all applicable regulations. ANY breached or leaking battery is managed as hazardous waste.

Before initiating the disposal process for the Li Expander Pak, it must be fully discharged. Next, consult the local Hazardous Waste Storage Area (HWSA), Defense Reutilization and Marketing Office (DRMO), or other local authorities for the standard operating procedure for packaging, quantity, labeling, shipping, and tracking requirements. If an HWSA or DRMO is not available or does not accept the Li Expander Pak, contact the servicing environmental compliance organization. Solar Stik is also able to handle disposal of the Li Expander Pak at a cost to the customer. Solar Stik can be contacted at 800-793-4364.

The Li Expander Pak contains recyclable materials, and recycling is encouraged over disposal if a lithium battery recycling facility is available.

The box in which the replacement battery was shipped is UN rated and should be used to ship the defective battery to the appropriate disposal location.

Technical Specifications

General	
Battery	(1) 24 VDC Lithium iron phosphate (LiFePO ₄)
Operating Voltage	24.0–28.8 VDC
Capacity	100 Ah
Energy Storage	2.4 kWh
Energy Density	48 Wh/kg
Max Charge Rate	50 A continuous
Max Discharge Rate	50 A continuous
Self-discharge Rate	<5% per month
Cycle Life*	≥ 3000 cycles to 80% State of Health
Shelf Life*	<ul style="list-style-type: none"> • 5.6 years to 80% State of Health • 7.0 years to 75% State of Health
User Interface	Ready/Fault push-to-check LED indicator
Transport Case	Pelican 1620
Transportation	<ul style="list-style-type: none"> • UN3841 Class 9 Lithium-ion batteries contained in equipment • Air transport by cargo aircraft only
Warranty	1-year materials and workmanship

*@ 77 °F/ 25 °C

Safety	
Breaker(s)	50 A Inter-connect circuit protection

Battery Management System Protection	
Overvoltage Limit	29.2 V
Undervoltage Limit	21.6 V
Overdischarge Current Limit	120 A
Overtemperature Limit	160 °F (71 °C)

Accessories



24VDC 5' Inter-Connect Strip 7
P/N: 113-1000160



MKM BMS Reader
P/N: 20-0001004



24VDC Li Battery Maintainer 120/230
P/N: 14-1001000



24VDC 5' Inter-Connect Cable
P/N: 13-0000032
(available in custom lengths)

Connections	
DC	(1) 24 VDC lithium Inter-Connect port (Deltran 224-0061-BK)
Battery Data	(1) RJ-45 (for optional MKM BMS Reader)

Environmental	
Operating Temperature	-13 to +149 °F (-25 to +65 °C)
Charging Temperature	+41 to +113 °F (+5 to +45 °C)
Storage Temperature	-22 to +158 °F (-30 to +70 °C)
Humidity	0 to 95% RH noncondensing
Certifications	<ul style="list-style-type: none"> • MIL-STD-810G tested • Internal battery has passed UNDOT 38.3 testing and is certified to ship globally

Weights and Dimensions (L x W x H)	
Weight	110 lb (49.9 kg)
Dimensions	24.76 x 13.90 x 19.57 in (62.9 x 35.3 x 49.7 cm)

ADDENDUM – Understanding Li Expander Paks

LiFePO₄ Batteries and the Battery Management System (BMS)

This section provides information about the individual battery cells that are integrated into Solar Stik Li Expander Paks and the multi-functional BMS that maintains them. Additionally, safeguards to prevent failure are discussed.

LiFePO₄ Battery Chemistry

The Solar Stik Li Expander Paks contains a custom LiFePO₄ battery module that was designed, tested, and UN certified for use in the Solar Stik System.

There are significant advantages to using LiFePO₄ batteries in that they offer good electrochemical performance with low internal resistance. Key benefits include high current rating and long cycle life, good thermal stability, enhanced safety and good tolerance for stressful operating conditions:

- High cycle life; up to 3000 cycles*
- Rapid and deep discharges (can go to near 0% without hurting the cells*)
- Rapid recharge
- High energy density—twice that of lead-acid (double the energy for its weight)
- Safety: LiFePO₄ battery chemistry is as safe as lead-acid
- Other than passenger aircraft, transport regulations are the same as for lead-acid

* The cycle life of LiFePO₄ is generally advertised as 3000 cycles, but it may be affected by adverse operating temperature conditions (extreme heat and cold) and high C-rates (rate of current charge and discharge)

***Batteries must not be stored in a discharged state or they may become permanently damaged.**

The primary factors that determine the life-expectancy of a battery are:

- Cycles and Application
- Abuse and Improper Cycling

Either one of these forms of abuse alone could cause damage while the battery is not in service. A combination of these abuses will (most likely) cause damage while the battery is not in service. The duration of exposure to high heat will be directly correlated to the amount of damage done. These phenomena are not unique to LiFePO₄ batteries.

Storing Li Expander Paks in a hot container is unavoidable at times; however, the damage can be mitigated in two ways:

1. ALWAYS charge the Expander Paks fully before storage.
2. If Li Expander Paks are stored in a high-temperature environment for more than three (3) months, perform a maintenance charge on the system at three (3) months. The maximum time between services (FULL recharging) for a system stored in a climate-controlled environment is six (6) months. If it is stored in a high-heat environment, then more frequent inspection/charging is absolutely necessary.

Unlike lead-acid batteries, the VOLTAGE OF A LiFePO_4 CELL IS NOT AN INDICATION OF THE BATTERY'S SOC during cycling. Voltage CAN, however, be used to determine a battery's SOC at fully-charged and fully-discharged states.

This is a very important factor in understanding how to diagnose and maintain these batteries properly. LiFePO_4 chemistry batteries maintain high voltages up to the point that they are fully charged or discharged, at which point the voltage will rise or drop rapidly. This makes it difficult to use the battery's voltage to determine the actual SOC. This is precisely why regimented maintenance charging is vital.

Battery Management

A BMS ensures that individual battery cells are charged/discharged and maintained optimally. In a working configuration, lithium batteries usually require unique charging times, voltages, and amperages, and they can be easily and permanently damaged if they are not used with a proper BMS. Cell damage can range from significantly shortened life to general poor performance, and in extreme cases a damaged cell can overheat, causing an explosion or fire. The role of the BMS is simple: It controls the actual operating conditions of each cell, so that they do not exceed safety limits or cause damage to the cells.

Cells and BMS Overview

Lithium batteries operate in a much more confined spectrum of voltage and current than lead-acid batteries. Under/overvoltage conditions are tightly regulated by an internal protection circuit. However, just as with lead-acid batteries, irreversible damage can occur to a lithium cell when it is discharged below a certain voltage (Li Expander Pak is 2.5 V/cell) for an extended period of time.

Solar Stik Li Expander Paks contain eight (8) LiFePO_4 “supercells”. These cells require a complex BMS, which manages the supercells and their protection circuits. The BMS is solely responsible for enabling or disabling the battery “terminals” where any external circuit is connected (i.e., load, Expander Pak, solar charging source, etc.) and through which all current flows in and out. Each supercell has a cell-balancing device to make sure all of the cells in a battery are charged evenly and are synchronized with the other cells as they charge and discharge.

Note: Eight (8) supercells wired in series that are each at 2.5 V means that the battery voltage is 20 V, which is the terminal disconnect voltage, or low SOC threshold. If the eight (8) supercells are all at 2.9 V, then the battery voltage will be 23.2 V (terminal connection voltage). For the purposes of this discussion, we will be referring to the individual cell voltage because one cell alone at 2.5 V can cause the entire battery module to stop working.

All Solar Stik Li Expander Pak batteries have a BMS that consists of protection and cell maintenance circuits:

- The protection circuit monitors the cell voltages, temperatures, and current going through the battery. It also controls the input/output of the battery; when all of the conditions are good, current can flow in/out of the battery terminals. If the temperature, voltage, or current are outside of their preset limits, then the battery terminals are disabled and no current can flow in/out.

- The cell maintenance circuit manages the cell voltages, and actively balances voltages across the cells as the battery cycles. It calculates for parity across all eight (8) Super Cells, ensuring long operational life.

The Li Expander Pak 2400 offers a BATTERY STATUS LED located on the outside of the Expander Pak case.

The BATTERY STATUS LED circuit monitors and reports the output of the battery. If the STATUS LED controller senses the output has been disabled for any reason, it turns the LED to red. BATTERY STATUS LED is not connected to the BMS-computed SOC; it is only monitoring the output of the battery and indicating to the user if the terminals of the battery are active or not.

The Li Expander Pak 1300 battery BMS has only one control board for protection and cell management. There is no display or STATUS LED on the case.

Without the BMS protection circuit, there would be a significant safety risk. For example, if charging voltage and current are applied to a battery with dead or damaged lithium cells and no BMS, the remaining (functioning) cells would be exposed to higher individual voltages in order to compensate for the loss of dead cells in the battery. The external charging circuits would attempt to function by keeping the battery at its prescribed operating voltage, completely unaware that individual cells in the battery were being overcharged. With a BMS installed, however, the failure of a cell will trigger the protection circuit; thus the battery will protect itself and the operator.

Charging mechanisms used with ANY Li Expander Pak do not have the ability to recognize when a cell in a battery module has failed or, by extension, when a battery has removed itself from service. In any lithium battery that is made of multiple cells, that is the exclusive role of the BMS. External charging sources such as solar, vehicular, and the AC circuit will continue to attempt to charge at their set charging voltage values (in this case, at about 28 V) regardless of an individual cell's health or SOC. If one battery drops out of service, the system voltage is not affected, and the loss of one battery will have minimal impact on the overall system performance. If this situation is amplified, and multiple Expander Paks are removed from the system, then the system's performance will progressively degrade.

Additional Notes about BMS operation:

- The BMS is the key feature enabling the battery to handle high charge and discharge rates (up to 50 A each) and also allows multiple batteries to be used in concert (in a scaled configuration).
- In order for a scaled battery bank (multiple Li Expander Paks in a parallel connection) to function properly, the individual battery BMSs must be synchronized with each other. This is accomplished by fully cycling the bank 2–3 times after the batteries are connected.

Li Expander Pak in an Overdischarged State

It takes only ONE (1) supercell reaching a voltage of 2.5 VDC in an Li Expander Pak to cause an overdischarged condition. If the BMS senses that one cell has breached this low-voltage threshold, the protection circuit will immediately deactivate the battery terminals. This is also considered 0% SOC for the whole battery. This will protect the cell from going into a deeply discharged state, which can cause damage to the individual cell.

If the BMS has disconnected the battery terminals from service due to low SOC, it will continuously scan the terminals to see when charging voltage is being applied so it can reconnect the battery into service. This “sense” circuit is very active when the battery is first disconnected at the terminals due to low SOC. If the discharged condition persists and the cells are not recharged in a timely fashion, the cell voltages continue to deteriorate.

Self-recovery from an Overdischarged State

It is possible for a battery to self-recover from an overdischarged condition.

If the battery is discharged slowly (low current) to the point at which the protection circuits engage, there is only a minimal chance cells can reconnect on their own.

However, if the battery cells are discharged at a high rate, the chemical reaction inside the cells will often struggle to “keep up” with the demand, therefore, the voltage will drop and the protection circuit will disconnect the cells from service.

When cells are allowed to rest from a rapid discharge, the cells will continue to chemically react, causing voltage in the cells to rise. When the cell voltage recovers back above 2.9 V, the protection circuit will enable the output of the battery.

If either of these conditions occur, the battery should immediately be put into charge mode.

BMS Operation in an Overdischarged State

LiFePO₄ battery cells, as discussed earlier, will drop in voltage very quickly when they have reached low SOC. The BMS will disconnect the terminals to prevent further discharge by an external component, but the BMS itself requires power to operate. THE BMS WILL CONTINUE TO USE POWER FROM THE CELLS TO PERFORM ITS PRIMARY FUNCTIONS, even if the battery has disconnected itself from service. The cells will continue to discharge internally in support of the BMS functions, and the voltage can fall very rapidly to the point of non-recovery. If the battery protection circuit is engaged due to low SOC, you can be sure there is precious little energy left in the battery, so timely recharging is extremely important at this stage.

As time passes and the cells continue to lose voltage, the BMS will slow down its functions to preserve as much energy in the cells as is possible. One of these functions is to search for charging voltage at the battery terminals. Once the battery terminals are disconnected from service, the BMS uses a sense circuit to pulse the terminals, sensing for voltage. When the presence of higher voltage (greater than 23.2 V) is sensed at the terminals, it will begin allowing charging current into the cells.

The longer the battery has been in the discharged state, the greater the interval between the pulses; thus, the longer the charge voltage must be applied in order for the BMS to sense the voltage. In extreme cases where the cells have remained at the overdischarged state for an extended period, the BMS will pulse the terminals only sporadically; therefore, the Li Expander Pak may need to remain connected to a charging source for multiple days in order for the BMS to allow enough power back in through the terminals to effect a recovery.

Self-Discharge

LiFePO₄ has a higher self-discharge than other Li-ion batteries, which is exacerbated in high temperatures.

Bricking a LiFePO₄ Battery

As soon as the BMS senses the cell voltage is too low to discharge further, time is of the essence to place the batteries on charge. Failure to do this may cause a fatal error known as “bricking”.

Once the batteries reach their internal disconnect voltage, the voltage can fall very rapidly in the internal cells, causing the battery to brick. This means that the battery cells are non-recoverable, and the battery module must be replaced. (See LiFePO₄ Battery Disposal)

ABOUT SOLAR STIK, INC.



SOLAR STIK®

Mission Statement

Using American-made components and constant innovation, Solar Stik creates portable power solutions that enable self-sufficiency for the soldier, the sailor, and beyond. In doing so, we save lives, change lives, and help revive American manufacturing.

STIKopedia

[STIKopedia](#) is a compilation of everything you would ever want to know about portable Hybrid Power Systems, including the philosophy and mechanics of high-efficiency circuits, and the individual technologies used to create them.

Solar Stik Training and Education

- **Solar School (St. Augustine, FL)** provides an introduction to the design and support of small-scale, renewable-energy, power generation systems, with detailed explanation of system components. Advanced configuration options with hands-on deployment of actual systems will enhance student understanding.
- **Solar Stik New Equipment Training (on site)** teaches Hybrid System configuration options with hands-on deployment of actual systems to enhance student understanding.

Solar Stik Training Courses are tailored to the specific needs of the students. To schedule Solar Stik Training or to learn more about the curriculum, please contact us.

Contact

Technical Support Line

800-793-4364 Ext. 102

(24 hours a day, 365 days a year)

Address

Solar Stik, Inc.

226 West King Street

Saint Augustine, Florida 32084

Website

www.solarstik.com

Trademarks and Logos are the property of Solar Stik, Inc. unless otherwise noted.

This manual is subject to revisions without prior notice.

Copyright 2019 Solar Stik, Inc.

All Rights Reserved.